

A large, light gray, stylized graphic of a hand holding a tool, possibly a wrench or a similar instrument, is positioned in the background. The hand is open, with fingers slightly curled, and the tool is held between the thumb and index finger. The graphic is composed of several thick, rounded rectangular segments that form the fingers and the tool's handle and head.

NUSCO

ispirati dalla tradizione, progettati al futuro

Catalogo ad uso esclusivo dei rivenditori

NUSCO
ispirati dalla tradizione, progettati al futuro

Porte e infissi da tre generazioni

Gentile partner,

la Nusco SpA rappresenta una delle più solide realtà italiane nell'industria dei serramenti.

Dal 1968, anno di fondazione dell'azienda ad opera di Mario Nusco, offriamo una gamma prodotti che ha saputo adeguarsi alle mode e allo scorrere del tempo.

Negli anni, abbiamo arricchito la nostra offerta, che oggi, oltre alle porte, presenta una gamma completa di finestre in legno, legno alluminio, alluminio e pvc, oltre a persiane e grate di sicurezza. Scegliere Nusco vuol dire affidarsi ad un'azienda che può vantare una storia di 100 anni, oltre 3 generazioni, a riprova della nostra solidità e affidabilità.

Ci auguriamo che possiate trovare nel nostro catalogo prodotti che possano emozionarvi e rispecchiare l'amore e la passione che da sempre mettiamo nel nostro lavoro.

Luigi Nusco



il Gruppo Nusco è in possesso delle più prestigiose certificazioni a testimonianza degli elevati standard raggiunti nei processi produttivi e gestionali.

La qualità Made In Italy di porte, finestre, grate e persiane Nusco sono riconosciute a livello mondiale, grazie alla dimensione internazionale consolidata dall'azienda nel corso degli anni.





made in italy

storia e valori

La nostra misson è creare ambienti emozionanti, confortevoli e accoglienti per migliorare la qualità della vita.

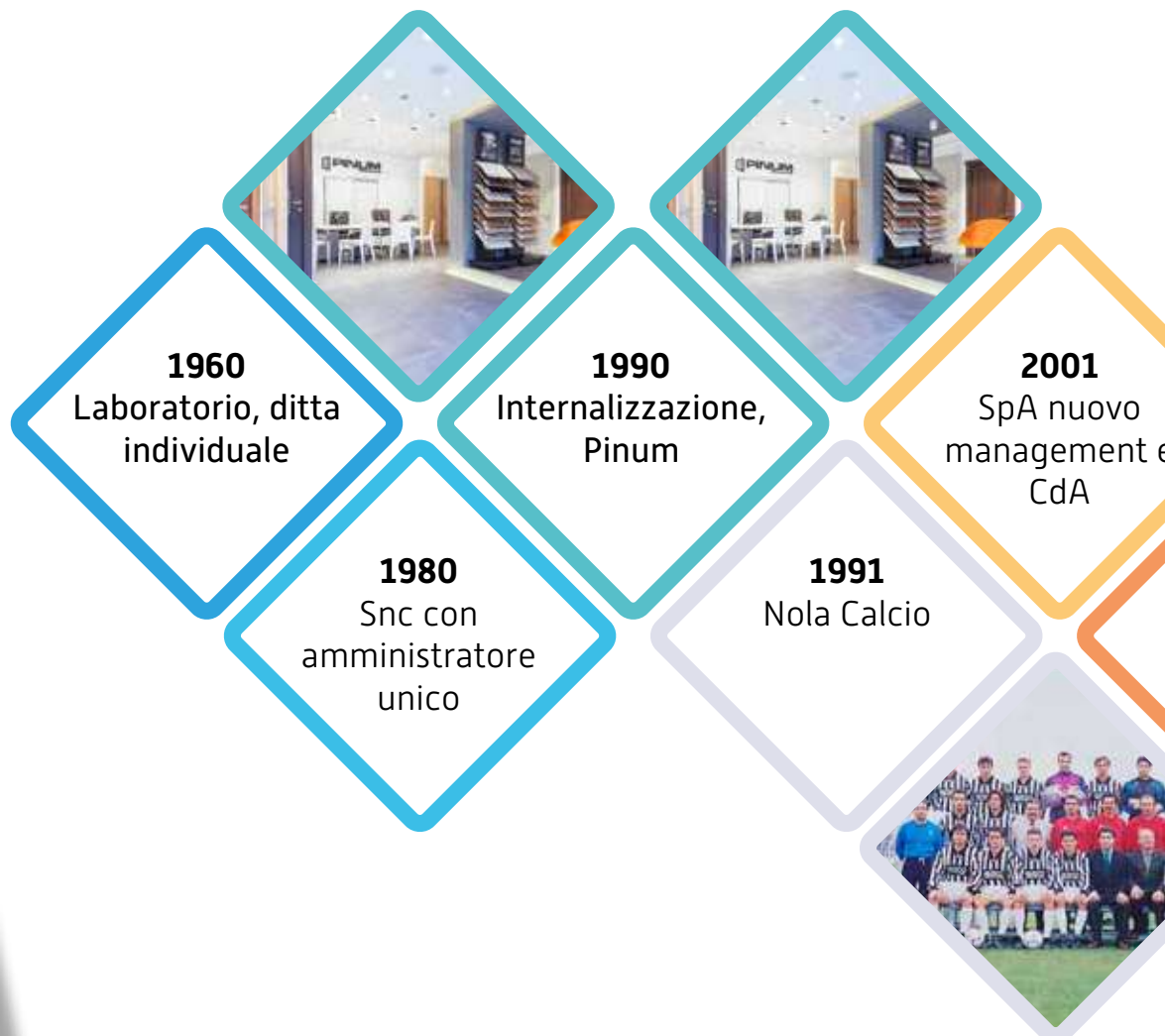
Da tre generazioni, Nusco è laboratorio della sartorialità, in cui la passione per il lavoro e la cura dei dettagli sono valori imprescindibili per la creazione di porte, infissi e sistemi "su misura".

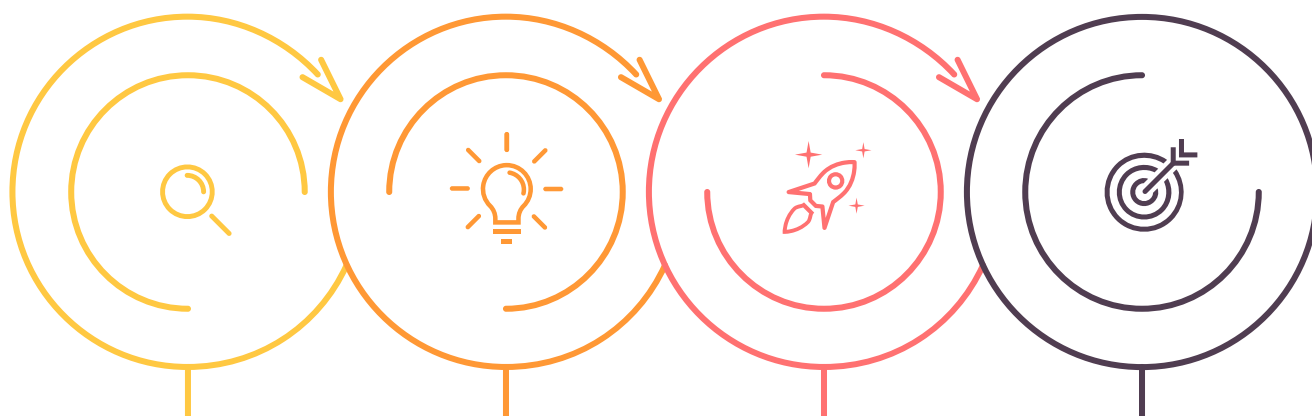



rispetto
fiducia
crescita personale

creatività
innovazione
sartorialità

affidabilità
trasparenza
serietà

soddisfazione del cliente
professionalità
cura

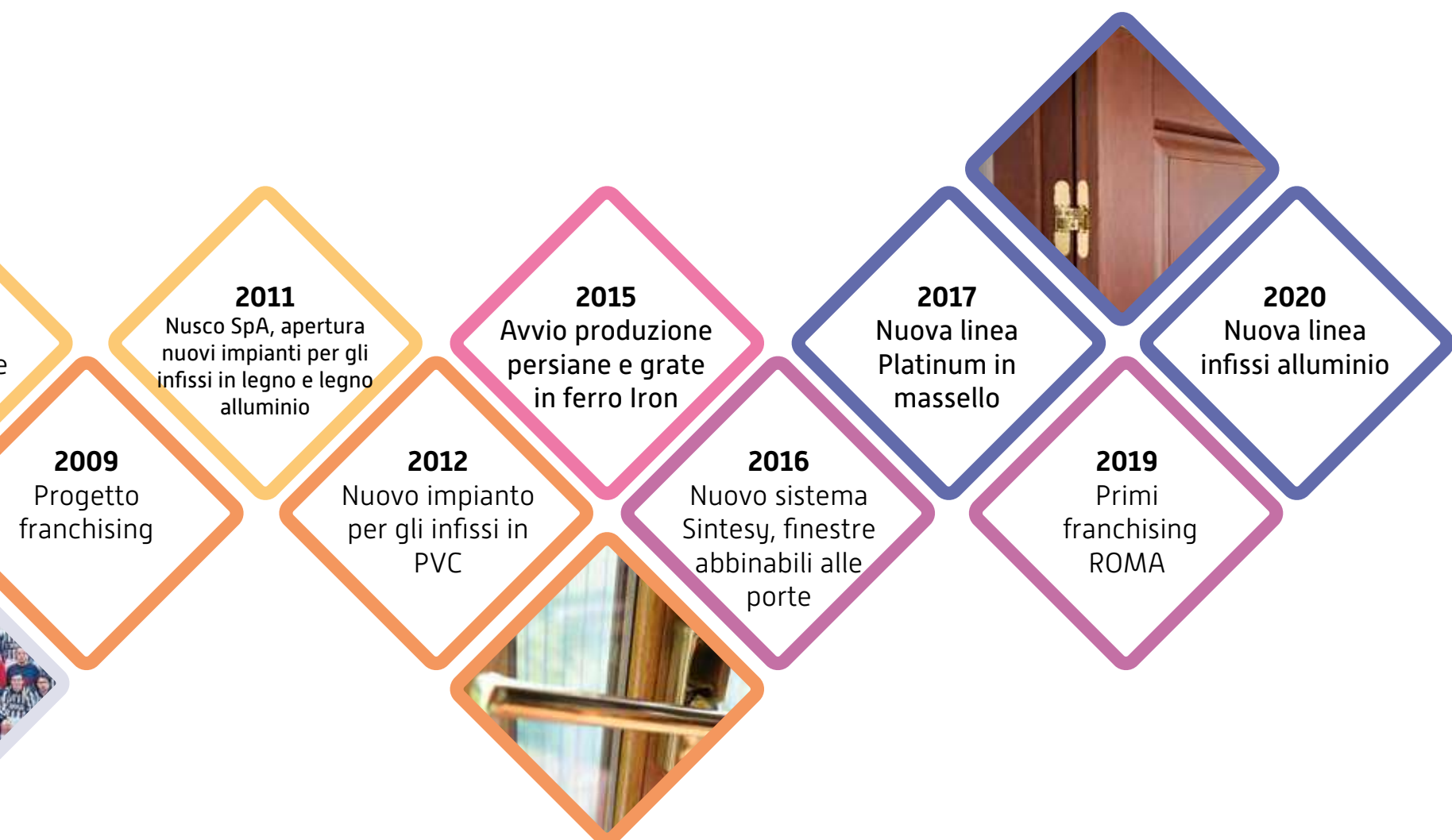

- Malta
- Egitto
- Tunisia
- Marocco
- Arzejbajan

- Francia
- Nigeria
- Panama
- Spagna
- Bulgaria

- Romania
- Cipro
- Arabia saudita
- Algeria
- Grecia

- Russia
- Emirati Arabi
- Libano
- Kuwait
- New York





nusco nel mondo

Un team di persone qualificate, serie e affidabili vi accoglierà nei nostri nuovissimi showrooms di porte, infissi e blindati.

Partecipiamo alle manifestazioni italiane ed estere più importanti al mondo, siamo presenti in tutta Italia con franchising e rivenditori.

Abbiamo accumulato un'esperienza tale da permetterci di essere tra i migliori produttori di porte da interno, infissi, blindati, persiane e grate di sicurezza.

I nostri prodotti rappresentano un passaggio generazionale tra la continuità e il design moderno, per soddisfare qualsiasi tipo di gusto.

Siamo pronti a ricevere le sfide del futuro.





Porte

Pantografate

linea Artwork	14
linea Quadra	20
linea Mirror ed Elegance	26
linea Fashion	32
linea Incise	38

Laminate

linea Texture	44
linea Ngl	50
linea Magnifica	56
linea Ideal	62
linea Vision	68
linea M-style	74
linea Evolution	80
linea Innova	84
linea Rever	90

Tranciato

linea Elite	96
--------------------	----

Massello

linea Platinum	102
-----------------------	-----

Lavorazioni speciali

Piego simmetrica / asimmetrica / rototraslante	110
Complanare	112
Scorrevole Magic	114

Filomuro

linea Filomuro Nusco	116
-----------------------------	-----

Vetri e decorazioni

Maniglie	122
----------	-----

Alluminio

linea Lux	126
------------------	-----

Blindati

134

Finestre, persiane e grate

Pvc

Max73	142
Power9000	

Legno

Cosmo68	148
---------	-----

Legno Alluminio

Cosmo68 Flat	154
Sintesy	

Ferro

Persiane e Grate Iron	164
-----------------------	-----

Alluminio

Infissi	170
Persiane Oscuria	



collezioni



PORTE



Un viaggio nella mente con l'ausilio di linee che solcano il legno vivo, incrociandosi e allontanandosi disegnano confini immaginari dai tratti sobri e decisi, contaminati da riflessi di luce ed effetti speciali.

Artwork nasce dal desiderio di creare un prodotto innovativo nella lavorazione ed elegante al tempo stesso.

La lavorazione si ottiene con frese meccaniche che accarezzano il pannello sottoposto successivamente a laccatura dal nostro team di esperti verniciatori.

Artwork è il mondo in cui viviamo, è l'espressione dei 5 sensi.

Artwork è l'arte in una porta.

artwork

Suggerimenti senza confini





artwork model



artwork ellisse



artwork astratta



artwork dinamica



artwork sistema



artwork simply



artwork incanto



artwork double



sirio



twist



polar



sfumata01

artwork colori



Bianco



Avorio



Tortora



Grigio

Altri RAL a richiesta

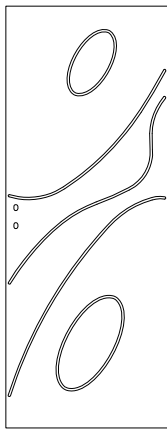

ELLISSE

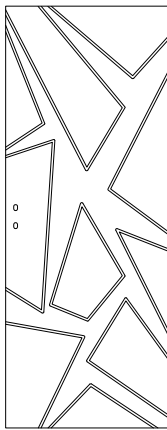

ASTRATTA

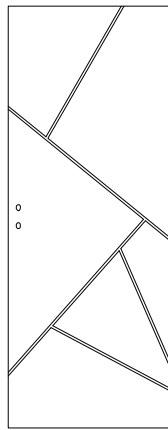

DINAMICA

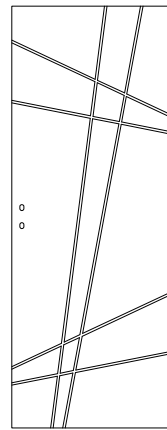

SISTEMA

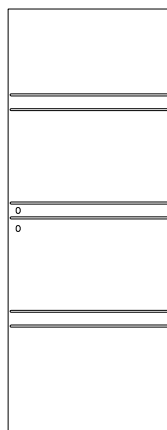

SIMPLY

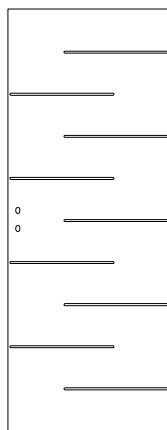

INCANTO

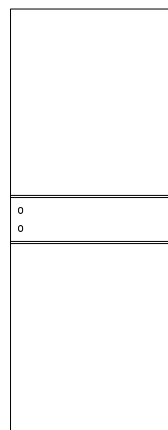

DOUBLE

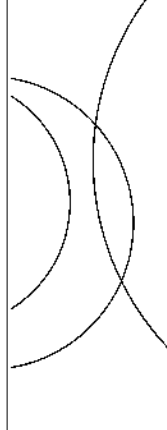

SIRIO

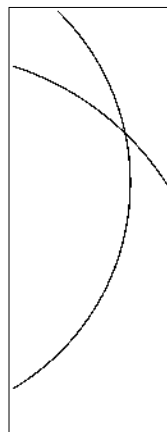

TWIST

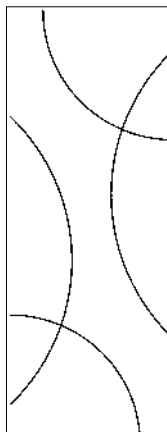

POLAR

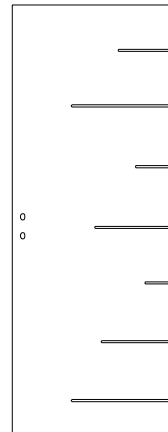

SFUMATA01

artwork technic

Di serie, telaio squadrato in listellare di abete e coprifili LSB (acquarius). Anta senza battuta, serratura magnetica e 3 cerniere a scomparsa regolabili di serie. Disponibile nelle versioni a battente, scorrevole a scomparsa, scorrevole a parete e nella versione complanare.

Cerniera a scomparsa



Serratura magnetica



LSB

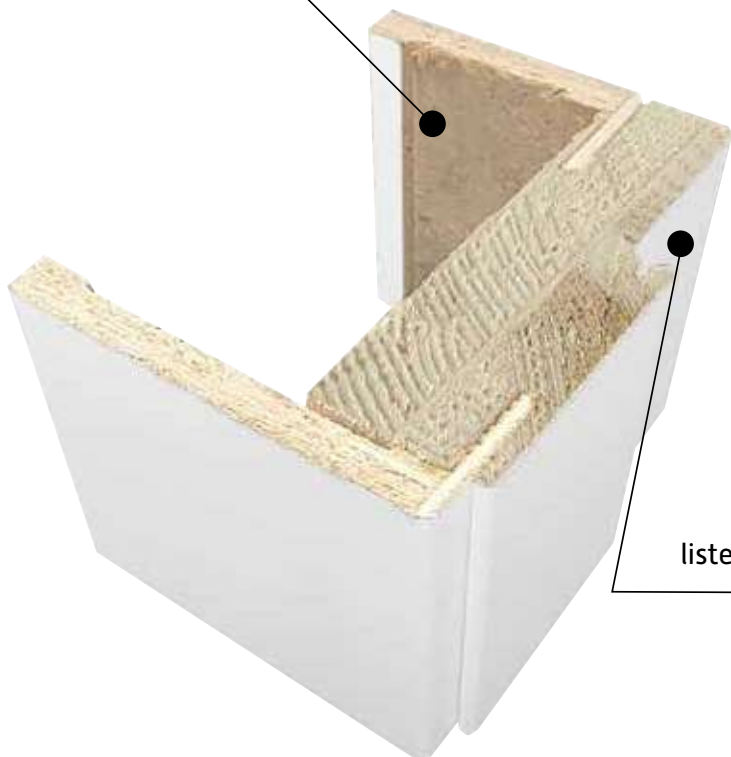

listellare

QUADRA

soluzioni innovative
dal design moderno

Contemporaneità per ogni ambiente, nella nuova collezione Quadra Nusco. Le finiture laccate si abbinano alla linearità degli elementi, per un design minimal ma deciso. Elegante elemento d'arredo e design, si adatta con stile e versatilità agli ambienti domestici







quadra model



1B



2B



3B



4B

quadra colori

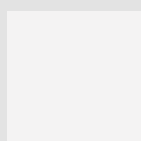

laccata bianco puro RAL 9003

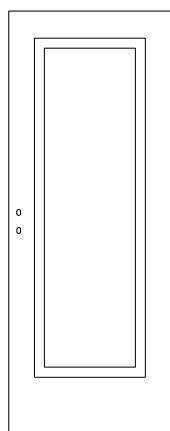

1B

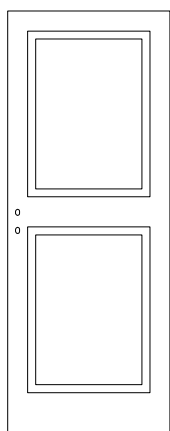

2B

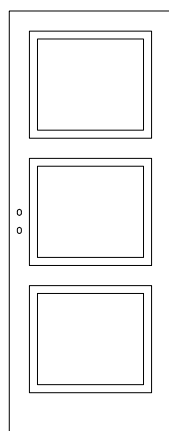

3B

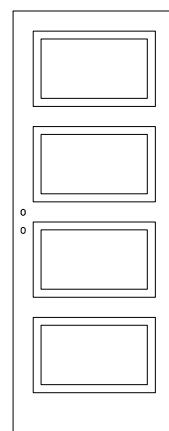

4B

quadra technic

Di serie, telaio squadrato in listellare di abete e coprifili LSB (acquarius). Anta senza battuta, serratura magnetica e 3 cerniere a scomparsa regolabili di serie. Disponibile nelle versioni a battente, scorrevole a scomparsa, scorrevole a parete e nella versione complanare.

cerniere a scomparsa regolabili

LSB

listellare

Serratura magnetica

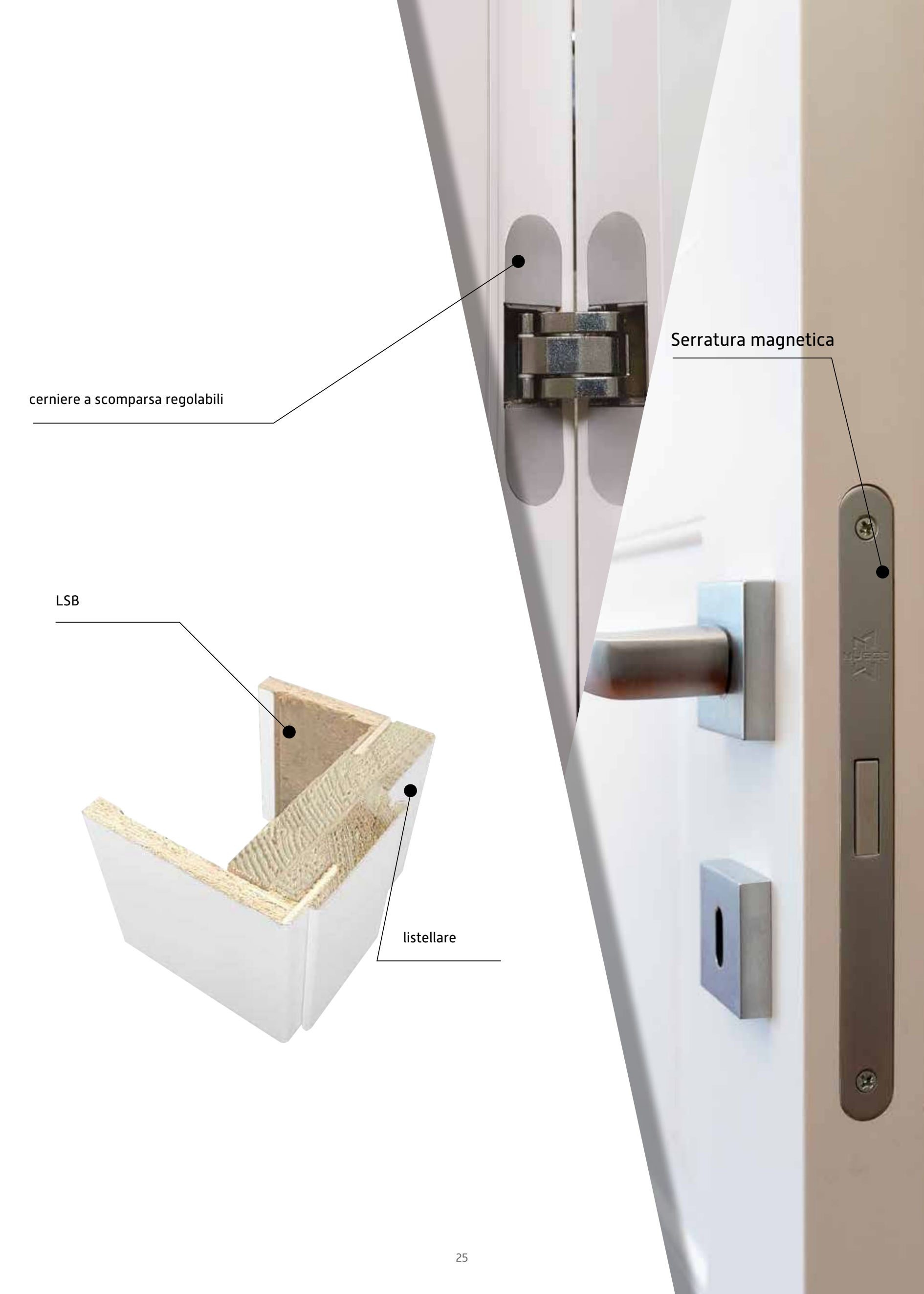

MIRROR ED ELEGANCE

suggerzioni senza confini

Eleganti giochi di vetro e fodere, dal design minimal,
che arredano gli ambienti domestici con stile.
Nascono così i nuovi modelli Mirror ed Elegance.







mirror ed elegance model



artwork mirror 200



artwork elegance 80



artwork elegance 200



artwork elegance 40-110

mirror ed elegance colori



Bianco

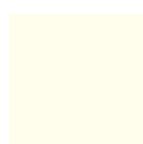

Avorio



Tortora



Grigio

Altri RAL a richiesta

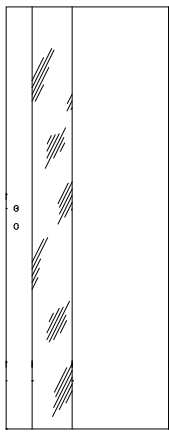

artwork mirror 200

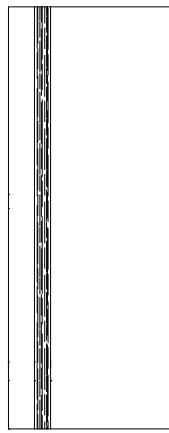

artwork elegance 80

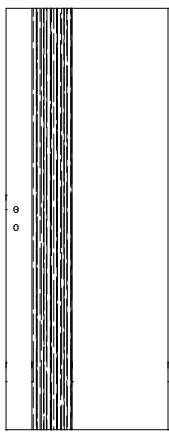

artwork elegance 200

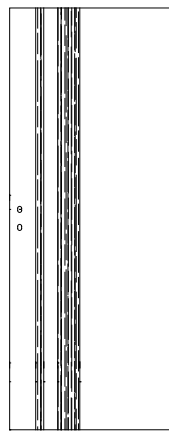

artwork elegance 40-110

mirror ed elegance technic

Di serie, telaio squadrato in listellare di abete e coprifili multistrato piatti.

Anta senza battuta, serratura magnetica e 3 cerniere a scomparsa regolabili di serie.

Disponibile nei colori bianco, avorio, tortora, grigio ed altri Ral a richiesta.

Cerniere a scomparsa



Vetro laccato

LSB

listellare

LINEA FASHION

lo stile prende forma

Design e stile si fondono nella linea Fashion, nata per rispondere alle esigenze d'arredo per ambienti moderni e luminosi.







linea fashion model



favolosa*



fashion 01



incantevole

linea fashion colori

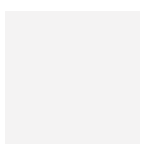

Laccata
bianco

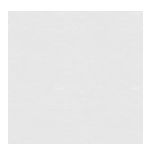

Frassino
bianco



Dress chiaro



Palissandro
white



Olmo



Grey

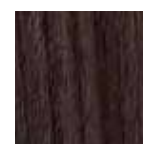

Palissandro
Blue



Noce
Greenwood

*Favolosa realizzabile solo in laccato bianco.

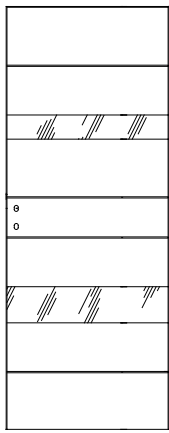

favolosa

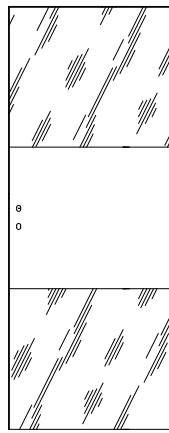

fashion 01

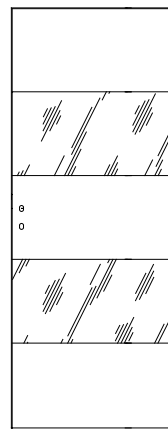

incantevole

linea fashion technic

Vetri laccati bifacciali simmetrici su entrambi i lati della porta.

Telaio e coprifilo LSB da 70/100.

Anta con battuta in alluminio, per una maggiore robustezza ed un forte impatto estetico e di design.

Serratura magnetica e 3 cerniere a scomparsa regolabili di serie.

Cerniere a scomparsa

anta con battuta in alluminio

vetro laccato bifacciale
su entrambi i lati



PANTOGRAFATE e INCISE

personalità e versatilità

Nuove nelle linee, dalla semplice pannellatura in fibra di legno, nascono le porte laccate e incise. Rigore, decisione e una straordinaria varietà di forme, per pannelli che disegnano superfici solide. Disponibili su richiesta in un'ampia gamma di colori, queste porte contribuiscono a dare un tocco di personalità anche alle case di maggior prestigio, adattandosi agli stili più svariati.





pantografate e incise model



ovale



mediterraneo 2PB



3PB



inciso 01



inciso 02



inciso 05

pantografate e incise colori

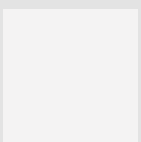

laccata bianco puro RAL 9003

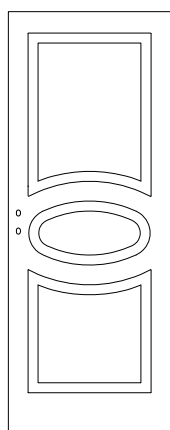

OVALE

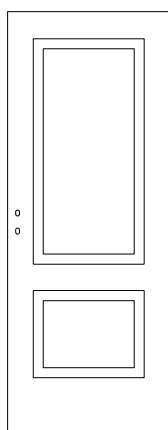

MEDITERRANEO 2PB

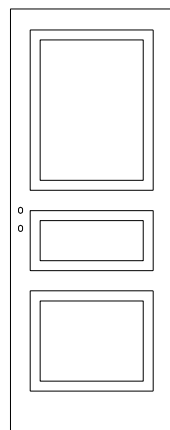

3PB



INCISO 01

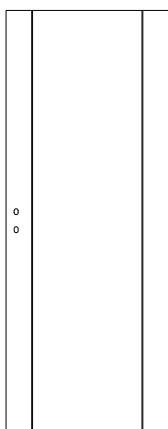

INCISO 02

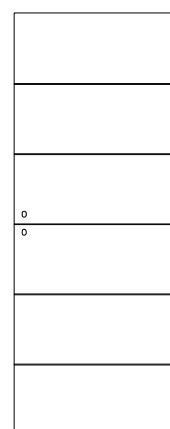

INCISO 05

pantografate e incise technic

Telaio squadrato in listellare di abete e coprifili Isb [acquarius].

Anta senza battuta, serratura magnetica e cerniere a scomparsa regolabili di serie.

Disponibili nelle versioni a battente, scorrevoli a scomparsa, scorrevoli a parete.

Serratura magnetica

cerniera a scomparsa regolabili
(med 2pb, 3pb e ovale)

LSB

listellare



TEXTURE

innovazione
e stile moderno

Dalla ricerca di Nusco SpA nasce una linea dal design semplice e dalle superfici lisce e delicate, caratterizzata da un forte coinvolgimento sensoriale, grazie alle proprietà dei materiali ed alle particolari texture, piacevoli al tatto e alla vista.

La speciale lavorazione e l'uniformità delle finiture donano resistenza e solidità per rendere duratura sia la piacevolezza estetica che la consistenza della porta.





texture model



texture



texture 01



texture 02



texture 03



texture 04



texture 05



texture 06



1 VG

texture colori

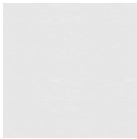

Frassino bianco



Dress chiaro



Palissandro white



Olmo



Grey



Palissandro Blue



Noce Greenwood



Laminato bianco

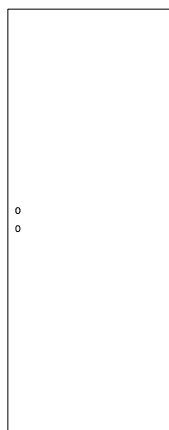

TT

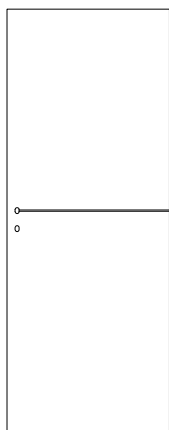

TEXTURE 01

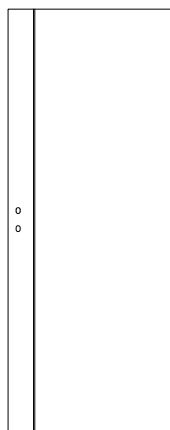

TEXTURE 02

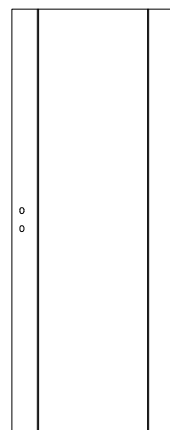

TEXTURE 03

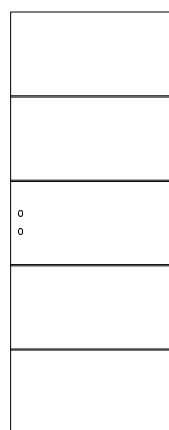

TEXTURE 04

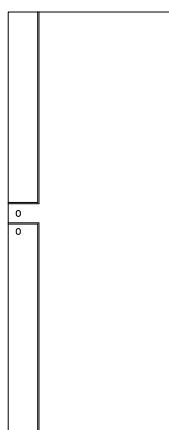

TEXTURE 05

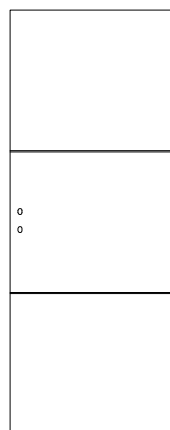

TEXTURE 06

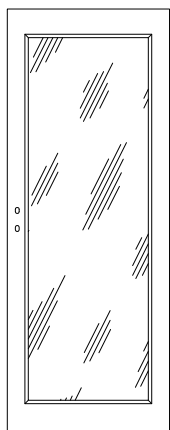

1VG

texture technic

Anta senza battuta e serratura magnetica di serie. Telaio e coprifili Acquarius [Lsb] su tutte le essenze, ad eccezione della laminatino bianco. Disponibile nelle versioni a battente, scorrevole a scomparsa, scorrevole a parete, piego.

Il telaio Acquarius è resistente all'acqua.

Realizzato al 100% in sfogliato di pioppo, per garantire leggerezza ed alte prestazioni, è costituito da grandi strand orientati, che ne assicurano un'ottima stabilità.

La struttura esterna è realizzata con sottili particelle di legno, per ottenere una superficie liscia e dura, adatta alla copertura con carta sottile. La resina MDI senza formaldeide, utilizzata per l'incollaggio, garantisce buone prestazioni in ambienti umidi.

Texture laminatino bianco disponibile solo nella versione a pannello e 1vg, con cerniere a scomparsa di serie. Telaio squadrato sandwich con coprifili in mdf da 7 e da 10 cm.

telaio acquarius

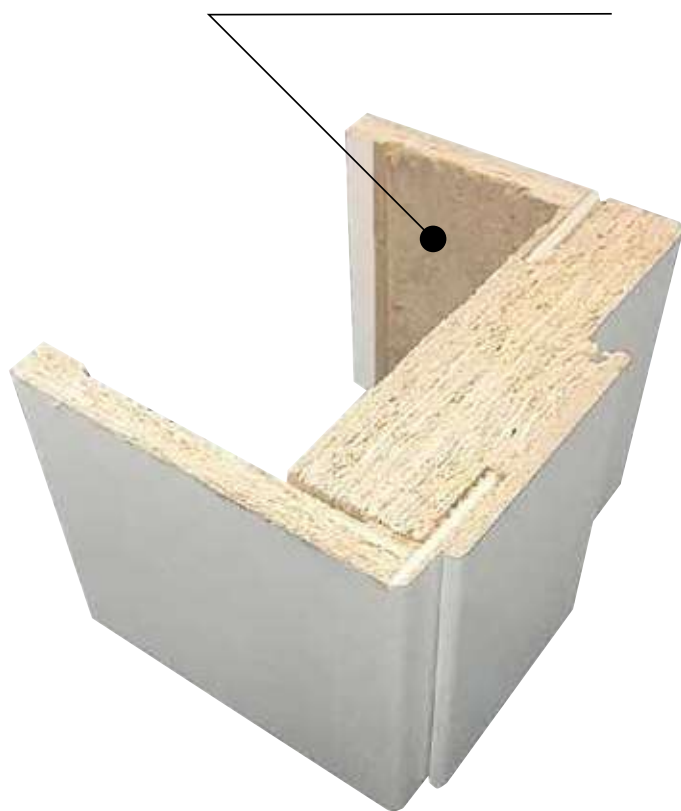

Telaio squadrato sandwich solo per essenza laminatino bianco



Serratura magnetica





NGL

Essenzialità e raffinatezza

Linee sinuose intarsiano la porta senza mai incontrarsi,
si sfiorano ma non si toccano.

Gli inserti in alluminio lucido esaltano i colori del pannello.

La linea NGL dà vita a un nuovo concept di essenzialità rivolto
a un pubblico dal gusto raffinato.



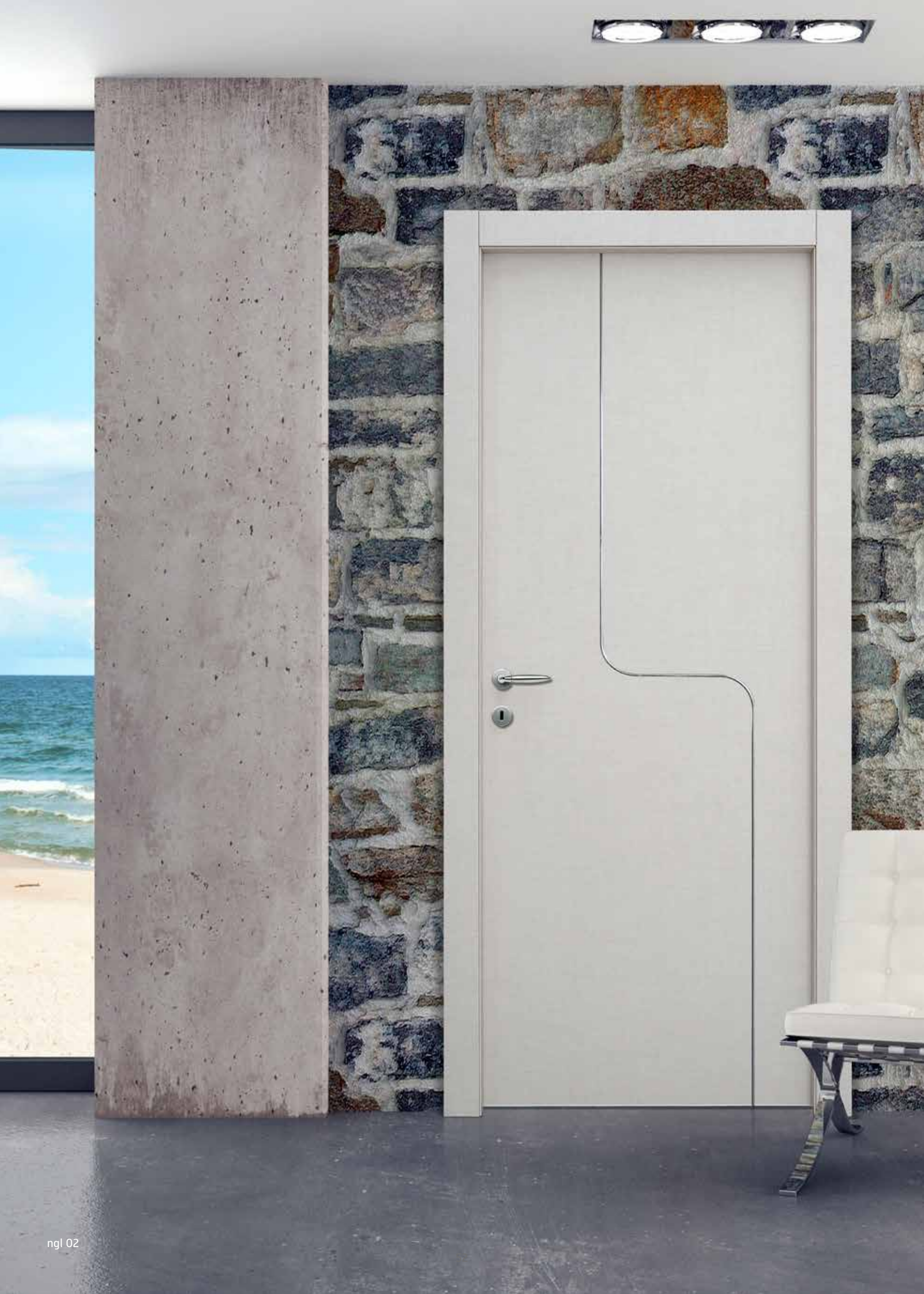

ngl model



ngl 01



ngl 02



ngl 03



ngl 04

ngl colori

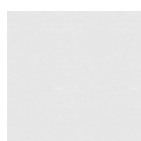

Frassino
bianco



Dress chiaro



Palissandro
white



Olmo



Grey



Palissandro
blue



Noce
Greenwood

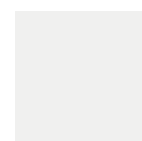

Laminatino
bianco

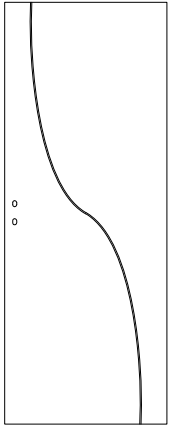

NGL 01

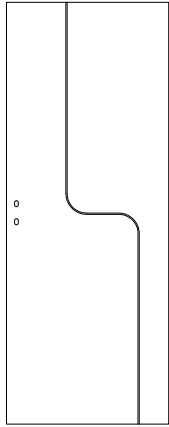

NGL 02

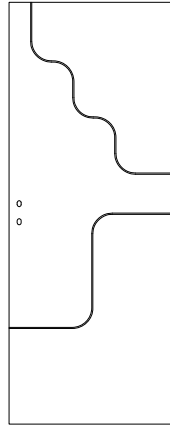

NGL 03

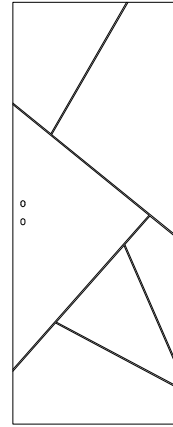

NGL 04

n gl
technic

Telaio complanare con cerniere a bilico e serratura magnetica.
Inserti in alluminio satinato.
Disponibile anche con cerniera a scomparsa.

Serratura magnetica



inserti in alluminio curvo

telaio acquarius

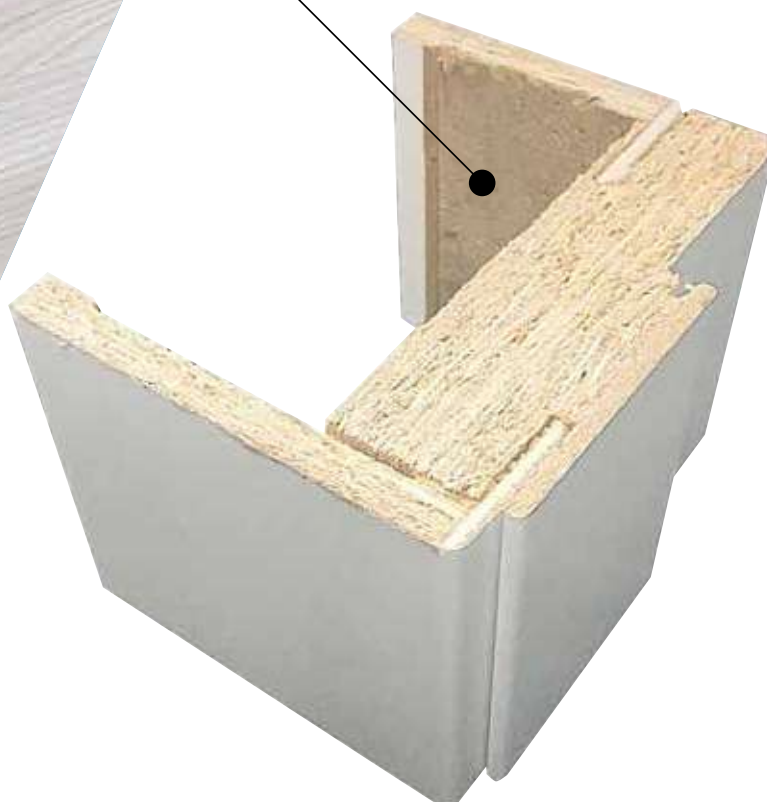



MAGNIFICA

Eleganti combinazioni di linee

Luci e colori si fondono in magnifica. Dalla ricerca Nusco, una nuova concezione di porte, costruita con incastri di varie tipologie di pannelli (laccati e non).





magnifica model



magnifica colori



Frassino
bianco

altri colori su richiesta

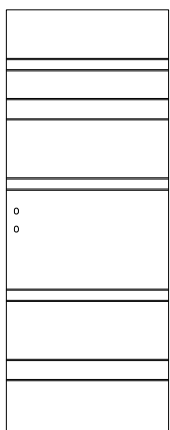

MAGNIFICA

magnifica technic

Di serie, cerniere a scomparsa e serratura magnetica.

Fascia centrale laccata in essenza.

Telaio acquarius.

cerniere a scomparsa

inserti laccati
su essenza



telaio acquarius

IDEAL

Eleganza e linearità

L'intuizione è lineare, pulita, diretta, genera idee. La linea Ideal esprime la visione dinamica del vestire ed interpretare lo spazio. Linee decise, che intrecciano venature e materiali. Essenze pregiate che cedono il passo ad inserti in alluminio o vetro. Superfici pulite che decorano e rifiniscono con garbo gli spazi del vivere quotidiano.







ideal model



ideal 02



ideal 03



ideal 04



ideal 07 V



ideal 08 V



ideal 11

ideal colori

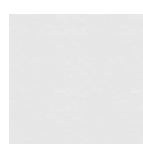

Frassino bianco



Palissandro white



Olmo



Grey

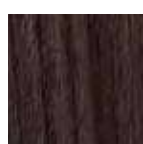

Palissandro blue



Dress Chiaro



Noce Greenwood

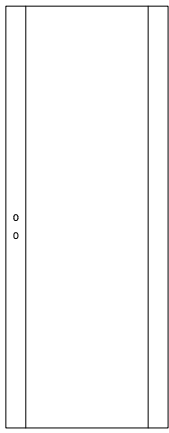

IDEAL 02

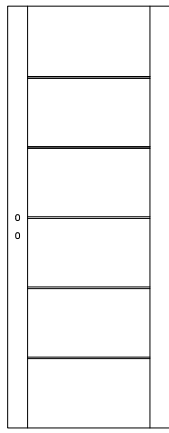

IDEAL 03

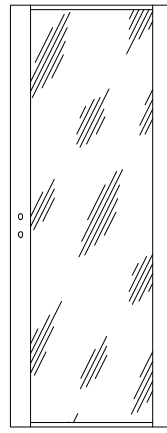

IDEAL 04

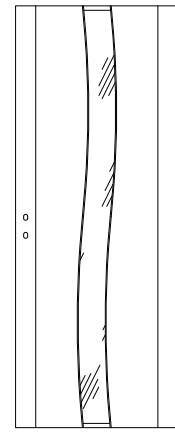

IDEAL 07

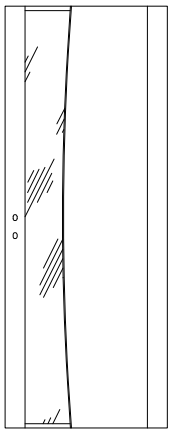

IDEAL 08

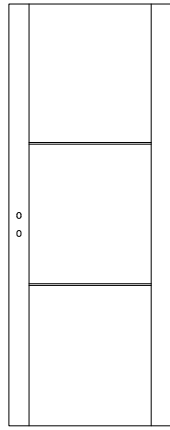

IDEAL 11

ideal technic

Pannello con spessore finito di 44 mm, costituito da supporti in mdf e controplaccato con CPL.

Profili di alluminio incastonati nei modelli illustrati.

Telaio acquarius e cerniere a scomparsa di serie.

Serratura magnetica



Cerniera a scomparsa di serie



telaio acquarius





VISION

bellezza che cattura

La bellezza che cattura lo sguardo, dettagli che passano attraverso gli occhi. Linee in movimento, inserti, incastri, preziose venature. Tutto in vision esalta le sensazioni di un impatto visivo forte dove le forme si caricano di significati. Dettagli che cambiano, spazi che si personalizzano perché stile è possibilità di rendere unico ciò che si desidera.
Vision: più di quanto immagini.



vision model



vision 01



new vision



vision trend

vision colori

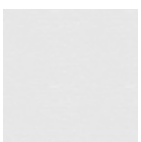

Frassino bianco



Palissandro white

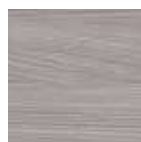

Olmo



Grey



Palissandro blue

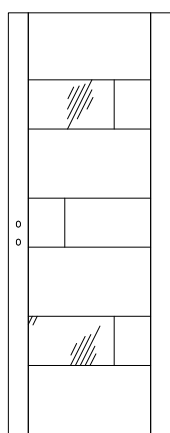

VISION 01

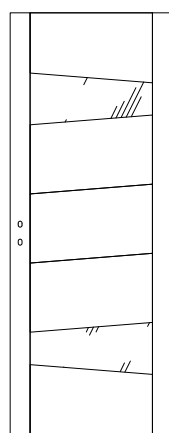

NEW VISION

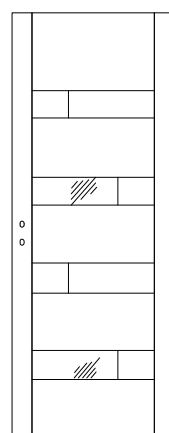

VISION TREND

vision technic

Telaio acquarius di serie. Montanti laterali realizzati in MDF con anima in listellare d'abete.
Stipite con guarnizione in battuta e coprifilo.
Il telaio è predisposto all'uso di coprifili con aletta per compensare meglio i vari spessori muro, le cui forme e dimensioni variano a seconda delle finiture.

cerniera a scomparsa



telaio acquarius

serratura magnetica







M-STYLE

il bianco che
fa tendenza

Stile e design minimal, per una
gamma che reinterpreta la
classicità del bianco con linee
essenziali e moderne.



m-style model



m-style02



m-style03



m-style04



m-style05

m-style colori

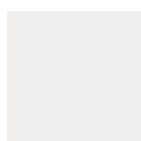

Laminato
bianco

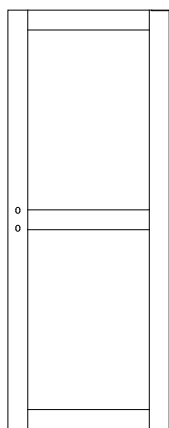

m-style02

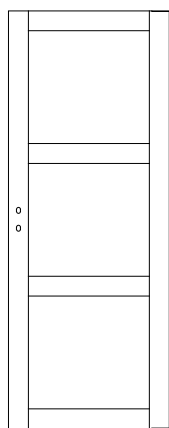

m-style03

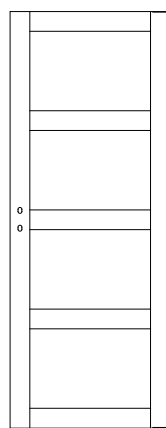

m-style04

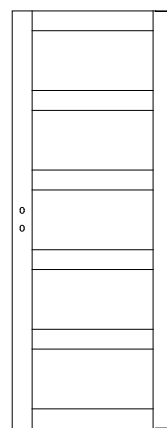

m-style05

m - style technic

Di serie, telaio sandwich listellare, coprifili in MDF.

Interni da 7 cm, esterni da 10 cm.

Anta senza battuta, cerniera a scomparsa, serratura magnetica.

Cerniera a scomparsa

anta senza battuta
e serratura magnetica

Telaio squadrato sandwich



EVOLUTION

Evoluzione della semplicità.

Evoluzione delle idee. Evoluzione dei materiali.
Da qui nasce la linea Evolution, con il suo
divenire di linee e materiali che si intrecciano e si
interscambiano.
Pregiate essenze, trasparenze del vetro.



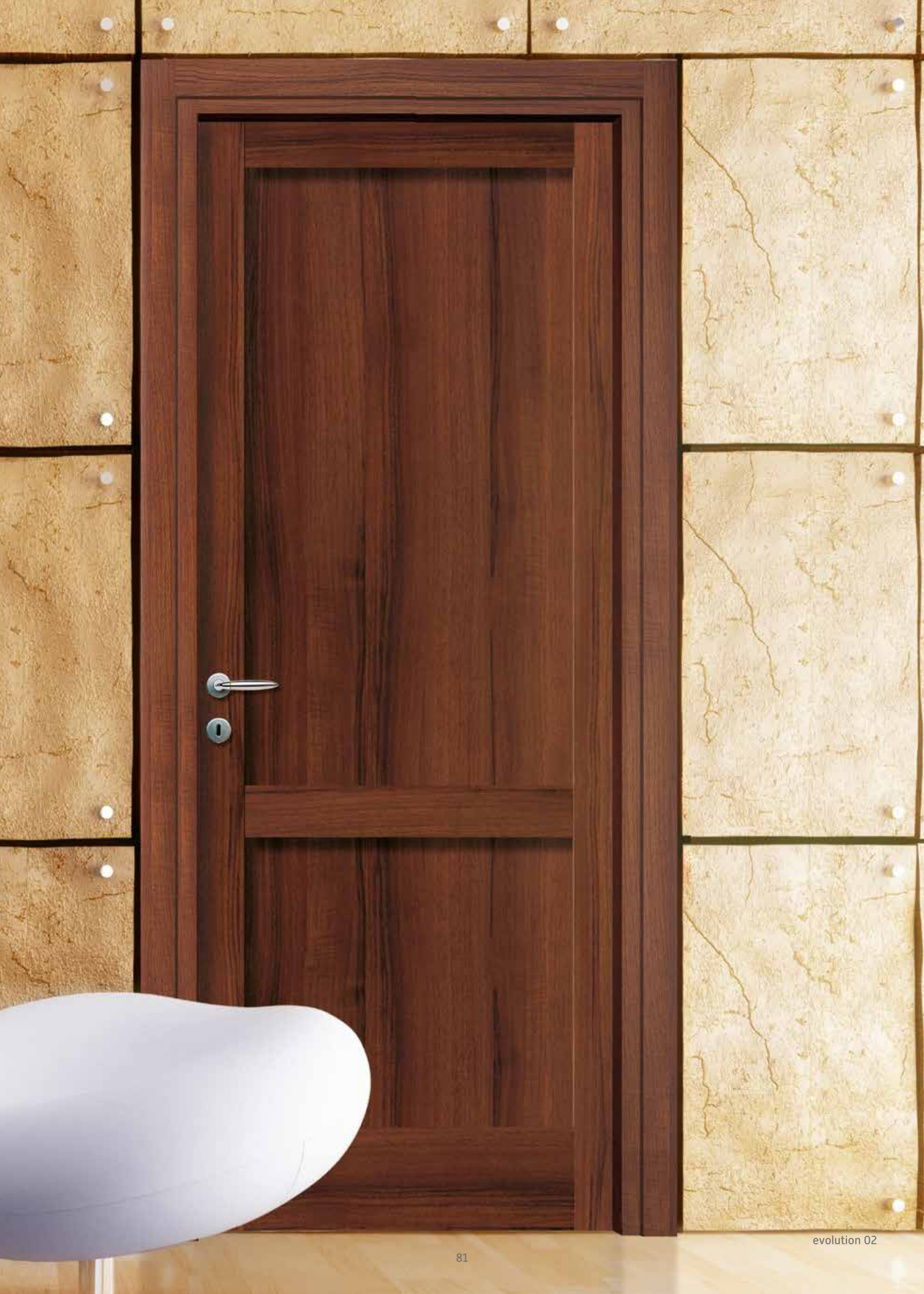



evolution model



evolution 01



evolution 02



evolution 03



evolution 01V



evolution 02V



evolution 03V

evolution colori

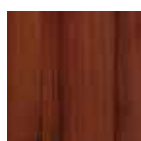

Noce nazionale

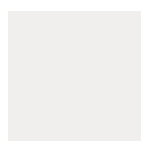

Laminato bianco

INNOVA

Praticità e convenienza

Le porte laminato della linea Innova sono rivestite di un materiale innovativo affidabile e resistente alle sollecitazioni ambientali offrendo, allo stesso tempo un ottimo effetto estetico. Porte pratiche, funzionali e convenienti, che valorizzano i grandi vantaggi del laminato: impermeabilità, resistenza all'umidità. Porte estremamente durevoli e stabili nel tempo. La gamma di colori delle porte laminate comprende molte essenze, con le varie sfumature, fedelmente riprodotte e cromaticamente resistenti. Una porta moderna, ricercata, dove la semplicità del design esprime la massima eleganza.







Gold
is the
new
Black

innova model



innova nt/cieca



innova nvg



innova linea 1



innova 01



innova 02



innova 03



innova 04



innova 06



innova tt
rovere sbiancato*



innova tt wengè*

innova colori



ciliegio



noce
nazionale

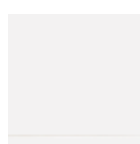

bianco

* i modelli tt sono disponibili solo nelle essenze wengè e rovere sbiancato. Disponibile anche versione a vetro.

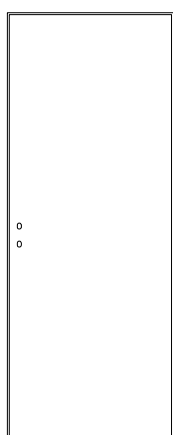

INNOVA NT

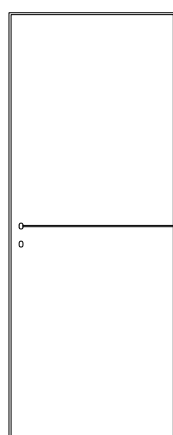

INNOVA 01

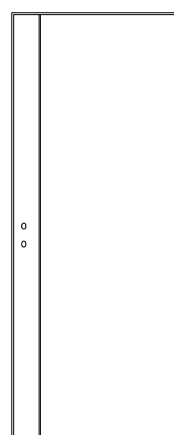

INNOVA 02

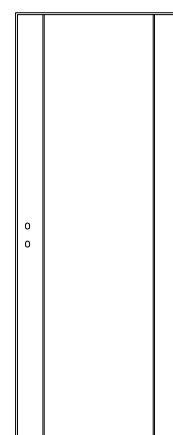

INNOVA 03

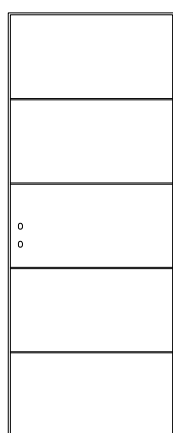

INNOVA 04

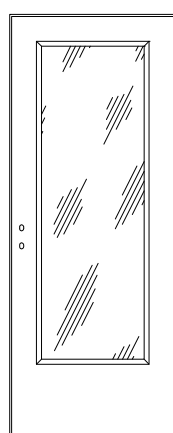

INNOVA NVG

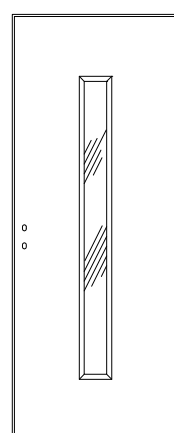

INNOVA LINEA 1



INNOVA05

innova technic

Materiali

Perimetrale in legno massello
Nido d'ape
Rinforzi serrature
Rivestimento in laminato
MDF

Versioni Eseguibili

Due ante simmetriche
Due ante asimmetriche
Scorrevole a scomparsa
Scorrevole a parete
Piego



kit telaio e coprifili squadrato (modelli tt)



telaio squadrato, coprifili piatti
per essenze bianco, ciliegio e noce
nazionale

REVER

moderna essenzialità

Linee dedicate a chi ricerca in una porta la semplicità del design e l'eleganza dell'essenza, nelle varietà di tutte le sue sfumature. Una porta elegante dalle linee semplici e con un ottimo rapporto tra qualità e prezzo.







rever model



rever 1



rever 2

rever colori

rever 1

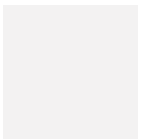

bianco



noce nazionale



rovere nat.



rovere grigio

rever 2



palissandro bianco

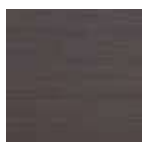

grigio perla



Noce Greenwood

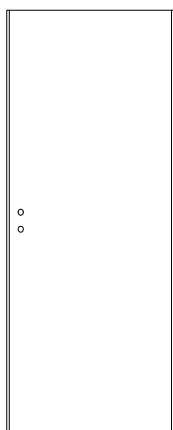

REVER 1

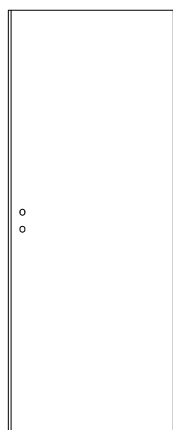

REVER 2

rever technic

rever 1

Di serie con anta reversibile (con battuta), cerniera anuba e serratura mediana cromo satinata.

Telaio squadrato disponibile da 11 cm, con coprifili in mdf da 7 cm.

Disponibile in PRONTA CONSEGNA nelle misure standard a battente [60/70/80/90]

e scorrevole a scomparsa 70/80/80.

rever 2

Di serie con anta reversibile (con battuta), cerniera anuba e serratura mediana cromo satinata.

Telaio squadrato da 10 cm, con coprifili piatti ad incastro in mdf da 7 cm.

Disponibile in PRONTA CONSEGNA nelle misure standard a battente [60/70/80/90]

e scorrevole a scomparsa 70/80/80.

rever 1 e 2

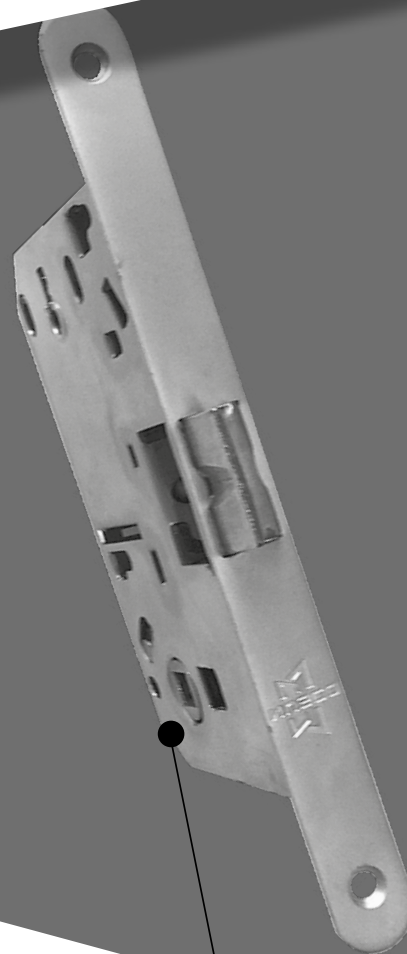
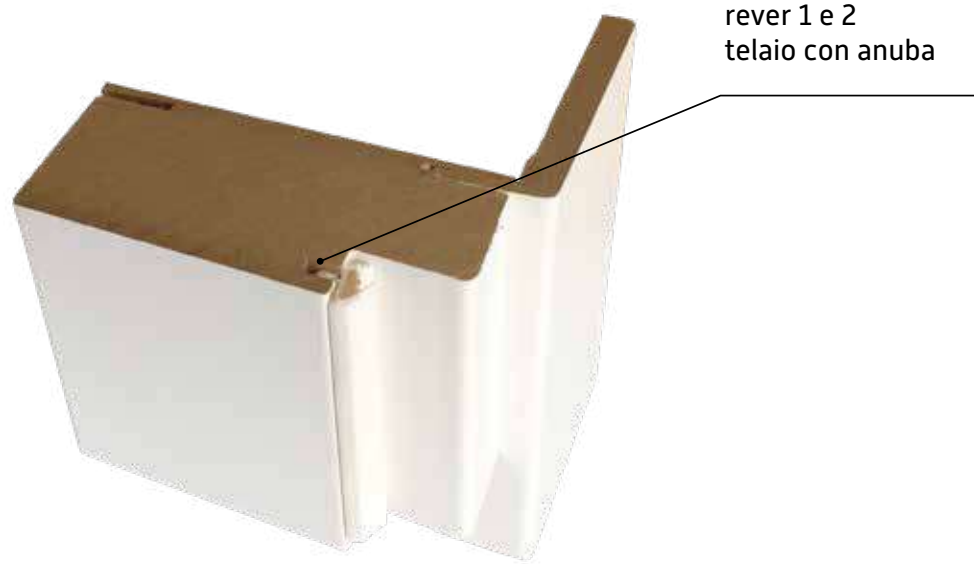



ELITE

Pregio senza tempo

La linea Elite è la collezione di porte senza tempo che utilizza materiali e finiture pregiate e vicini alle diverse esigenze di arredo. Un'ampia collezione di porte che offre la possibilità di caratterizzare gli ambienti con una nota di piacevole linearità. Eleganza della semplicità, linee e forme tradizionali fanno delle porte in tranciato della linea Elite Nusco la scelta naturale per ogni ambiente offrendo classe, un tocco di stile e ricercatezza agli ambienti ai quali vengono abbinati.





elite model



2PB



2PB-2DS



ovale



capri 1V/PB-DS



capri 1V/PB

elite colori

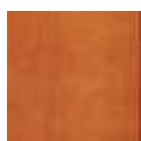

noce
tanganika
mielato



noce
tanganika
tinto



grezzo

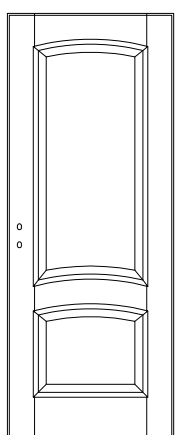

CAPRI 2PB-2DS

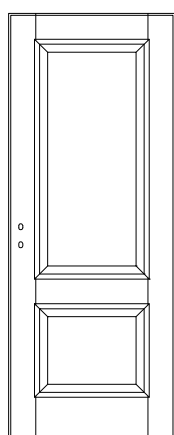

CAPRI 2PB

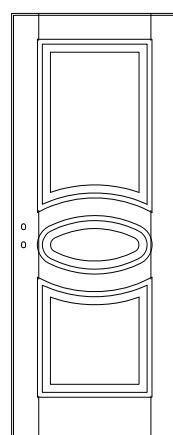

CAPRI OVALE

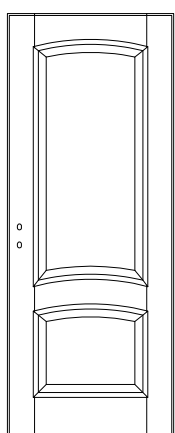

CAPRI 1V/PB-DS

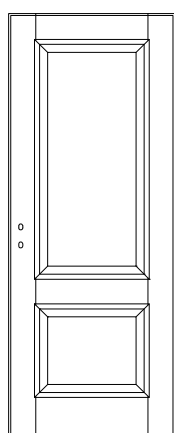

CAPRI 1V/PB

elite technic

Il pannello ha uno spessore finito di 43 mm, costituito da supporti in MDF (medium density fiber) controplaccato con tranciato nelle varie essenze di spessore 0,8mm. Il telaio perimetrale dell'anta è costituito in legno d'abete stagionato. Cornici ferma bugne in legno pieno verniciato. In prossimità dell'alloggio serratura vi sono blocchi in abete da 10 cm. Il bordo perimetrale è rivestito con tranciato da 1,2mm. Bugna centrale di forma ovale rivestita con tranciato.

Di serie kit telaio e coprifilo squadrato.



sezioni telai squadrati (di serie)





PLATINUM

Le porte in vero legno massello.

Rigore ed originalità, presente e futuro si uniscono armonicamente nella Linea Platinum in Massello, la collezione top di gamma Nusco, che deriva da una tradizione di oltre mezzo secolo nella produzione di porte in vero legno massello. Questa elegante soluzione d'arredo in stile classico fonde con sapienza ed equilibrio la pregiata robustezza del legno con moderne tecniche di produzione e particolari metodi di lavorazione, realizzando un prodotto dal fascino intramontabile e dalle performances d'avanguardia.





platinum model



Splendida



Galante



Pura



Vanitosa



Passionale



Meravigliosa



Audace



Gioiosa



Severa



Ovale

platinum colori

finiture nocino



moka



noce scuro

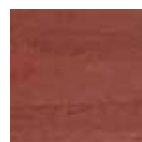

prugna



noce chiaro



miele



tortora chiaro



ciliegio



laccato
bianco

finiture rovere



rovere
verde terra



rovere
naturale



tortora
chiaro



mordenzato
bianco

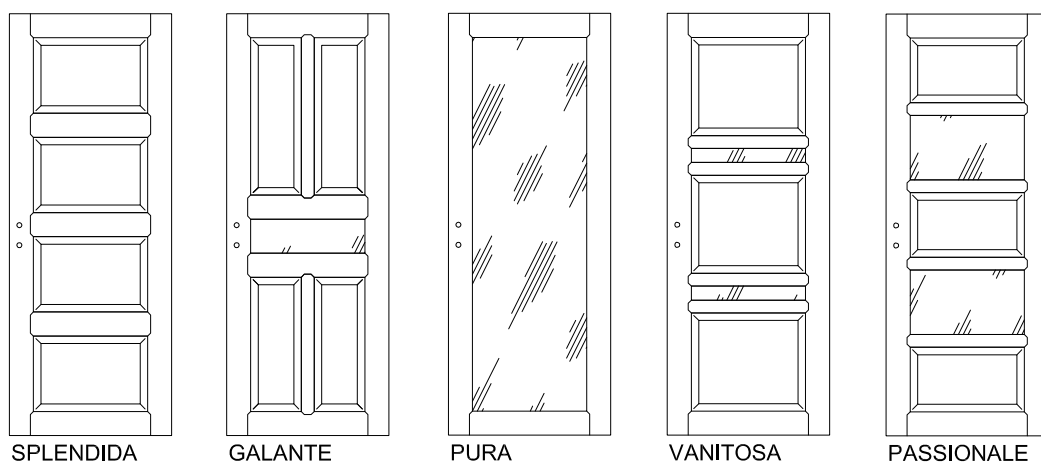

SPLENDIDA

GALANTE

PURA

VANITOSA

PASSIONALE

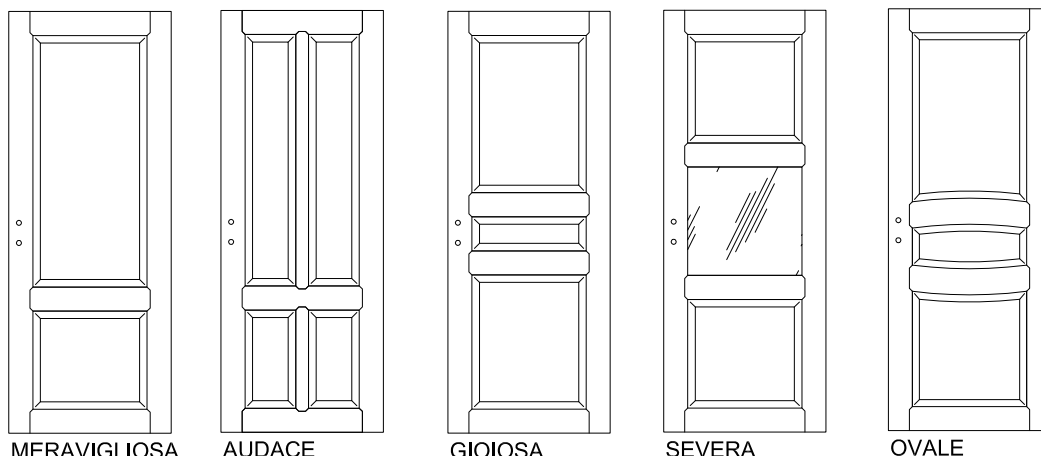

MERAVIGLIOSA

AUDACE

GIOIOSA

SEVERA

OVALE

platinum technic

Numerose varianti di stile, con la possibilità di scegliere tra le essenze rovere e nocino e diverse tipologie di telaio, coprifili e capitelli.

telaio massello



Cerniera a scomparsa



Classico



Barocco



Squadrato



Neoclassico



LAVORAZIONI SPECIALI

PIEGO

spazio funzionale

Il sistema Piego di Nusco nasce per abbinare design e funzionalità, nella realizzazione di un elemento di arredo che riesca a risolvere in modo elegante i più comuni problemi di spazio, laddove la porta rappresenti un ostacolo. In particolare, l'innovativo meccanismo del modello "rototraslante" si basa sullo spostamento del perno di rotazione dell'anta, consentendo una notevole riduzione del raggio d'apertura. Disponibile simmetrica e asimmetrica.





ROTOTRASLANTE





complanarità esterna, telaio
e cerniere a scomparsa

dettaglio contropiastra

maniglia minimal

Porta complanare

- Realizzabile su modelli color laccato bianco RAL 9003 nt liscia e linea artwork incisa e pantografata.
- Telaio squadrato in listellare
- Coprifilo interno da 70 mm ed esterno da 100 mm
- Cerniere a scomparsa regolabili di serie
- Anta senza battuta e serratura magnetica

SCORREVOLE MAGIC

La bellezza dell'essenzialità

Design essenziale ed effetto estetico d'impatto per il nuovo kit per porte scorrevoli Magic.



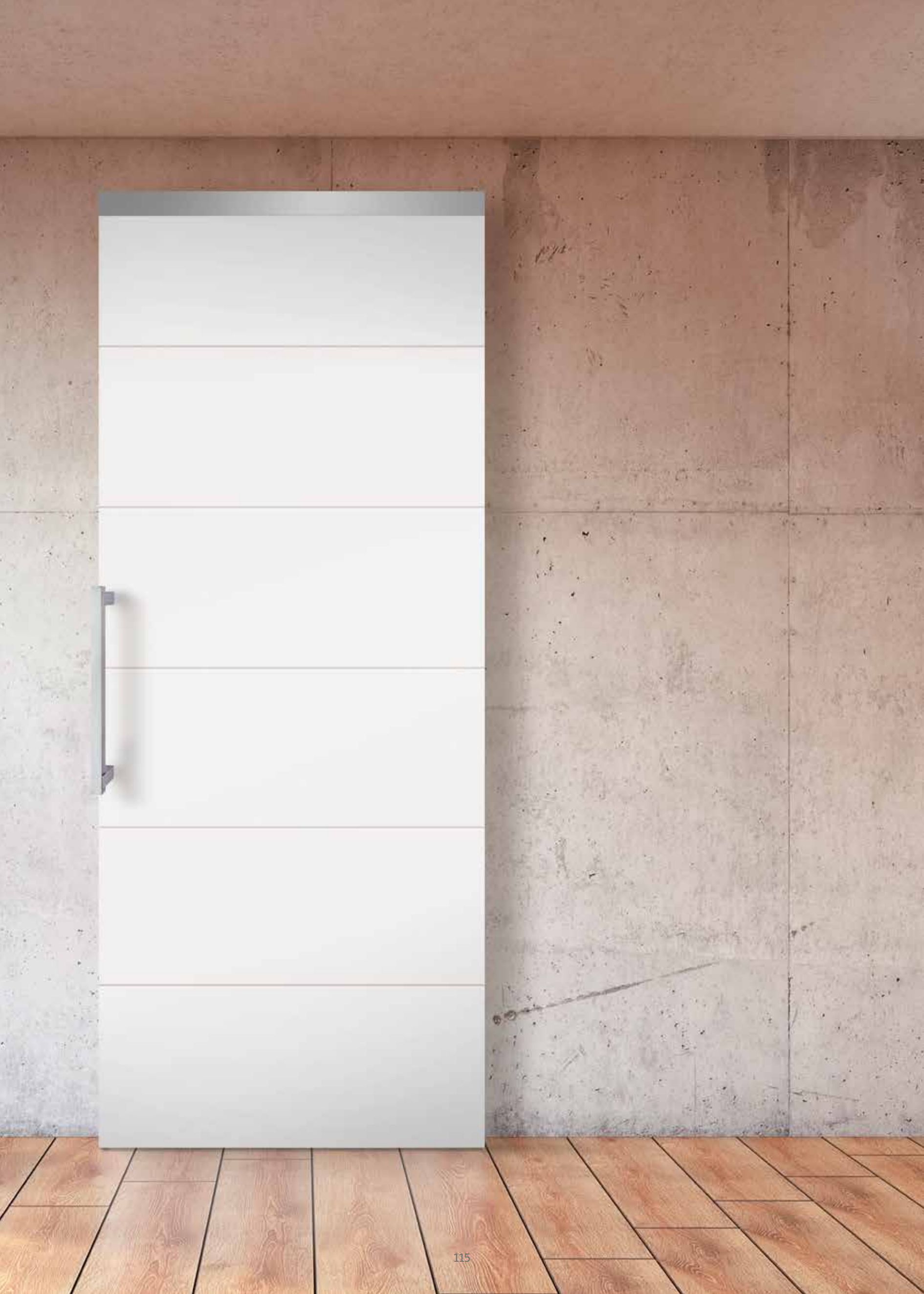



FILOMURO

design e bellezza

La porta filo muro risponde all'esigenza di una porta minimale complanare all'arredo. La filomuro Nusco offre la possibilità di avere l'anta in tinta con la parete ed è anche adatta a risolvere problematiche inerenti a posizionamenti particolari della porta (quali ad esempio sottoscala posizionati all'ingresso delle abitazioni, ripostigli interni o armadi a muro in camere da letto). Originariamente utilizzata per la risoluzione di problematiche estetiche, la porta filo oggi viene utilizzata da architetti e interior designer come elemento d'arredo per tutta la casa, grazie alle sue caratteristiche tecniche ed estetiche.





filomuro model



filomuro grezza



filomuro texture

filomuro colori

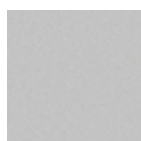

grezza

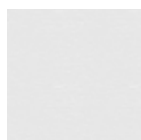

Frassino bianco



Dress chiaro



Palissandro white



Olmo



Grey



Palissandro Blue



Noce Greenwood

Essenza grezza disponibile in PRONTA CONSEGNA, nelle misure standard.
Tempi di consegna altre essenze texture: 20 giorni.

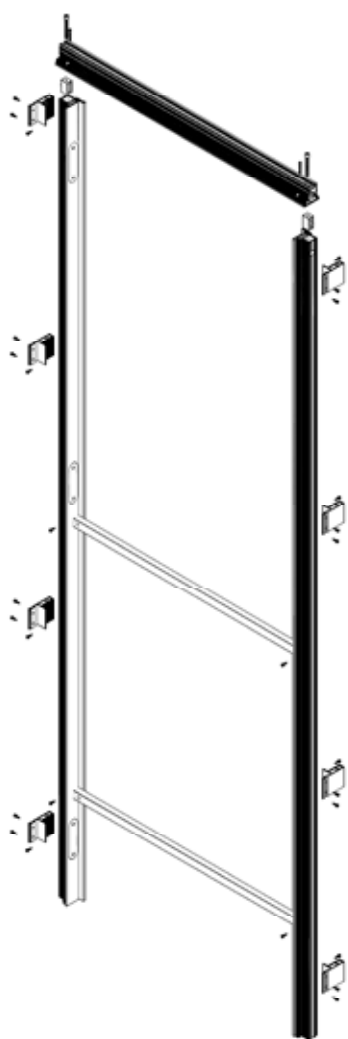

filomuro technic

FILOMURO REVERSIBILE completa di controtelaio, ferramenta standard e serratura magnetica cromo satinato.

Disponibile, con maggiorazione, maniglia ad incasso basculante e chiusura a rullo cromo satinato.

filomuro intonaco

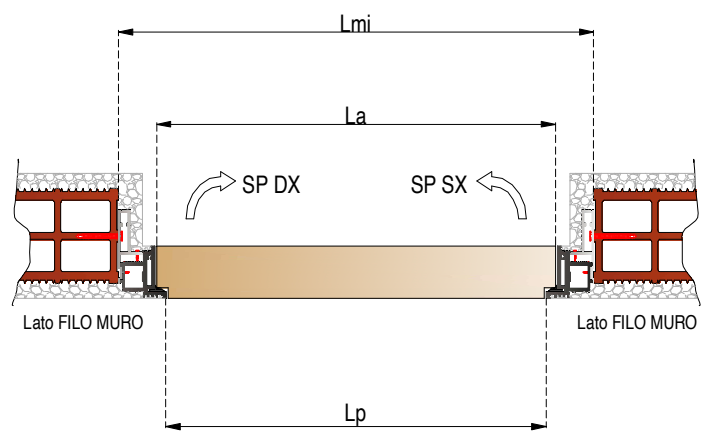
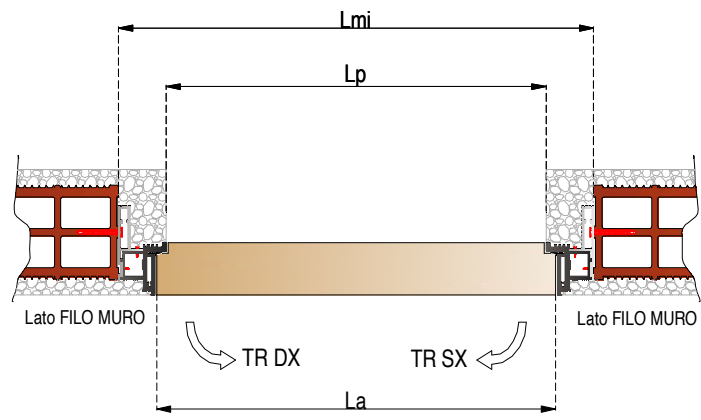
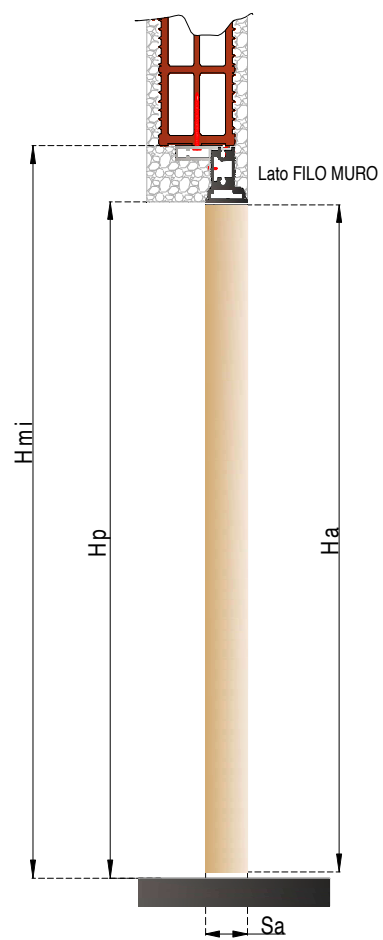

filomuro cartongesso

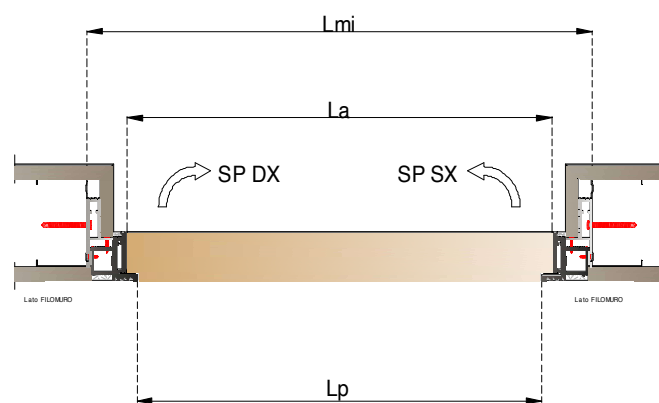
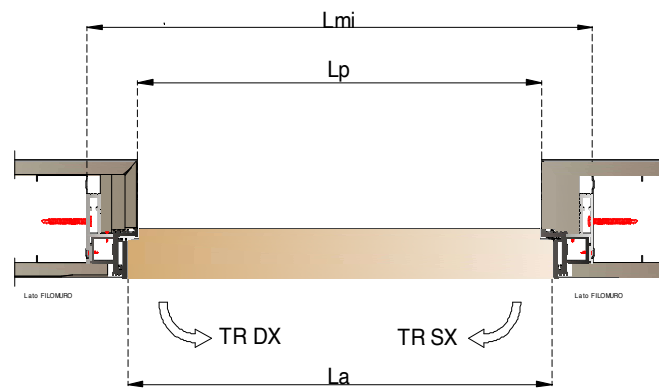
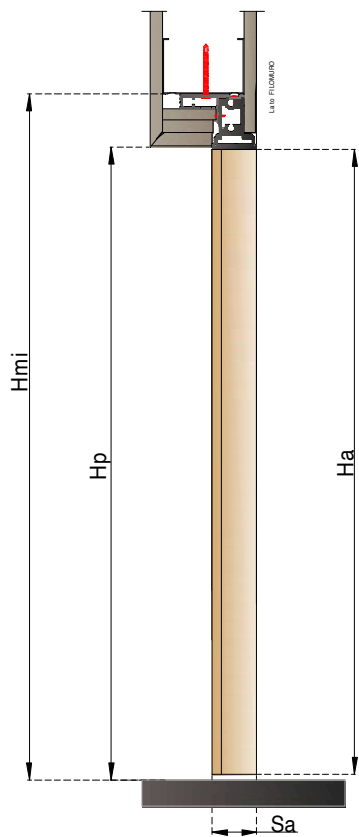

VETRI

Scintillio e magiche rifrazioni

Lo splendore degli Swarovski si sposa alla linearità del vetro. Un gioco di colori e trasparenze rappresentano il valore aggiunto di queste porte con vetri incisi a mano, della nuova Linea Vetri di Nusco SpA. Una grande varietà di temi e accostamenti cromatici esaltano tutti i modelli, sia classici che moderni, design by Matilde Durante. Le fasce in legno incorniciano il cristallo creando un gioco di continuità spaziale con il telaio della porta, sottolineandone la naturale linearità, in un unico insieme armonico.



vetri model



Tribale



Flower01



Diana01



Diana02



style 05



cielo



circus



ovale 01



Flower02



ovale 02

vetri model



ovale 03



calle 01



calle 02



zebrato



edera



style 02



style 03



style 04



Chrystal



Style06



ellisse



MANIGLIE

Le porte Nusco possono essere abbinare a numerose varianti di maniglie dei nostri partner, aziende leader del mercato.

maniglie model



rosita***



quadra***



kit scorrevole linea Modo***
cromo con nottolino



kit scorrevole Nusco
ottone con nottolino



kit scorrevole Nusco
cromo con nottolino



kit scorrevole linea modo***
cromo - versione con chiave



kit quadro Nusco



minimal



smart



style

***Disponibile nelle varianti ottone lucido o cromo satinato.

***Le foto sono puramente indicative del modello.



Sistemi ALLUMINIO

Funzionalità,
versatilità e bellezza

Gli spazi domestici del vivere quotidiano e gli ambienti dedicati ogni giorno al lavoro meritano un'attenzione particolare ed un'accurata scelta di forme, materiali e colori. Da questa considerazione prende vita la collezione Luxdoor di Nusco che propone soluzioni d'arredo progettate e realizzate con tecniche innovative, fedeli ai principi di massima funzionalità e precisione.









BLINDATI

sicurezza e solidità

Sicurezza, solidità e qualità sono le caratteristiche non troppo nascoste della linea Blindate.

Design per ogni gusto per il pannello esterno di queste porte dalla comprovata resistenza, che impressionano per la sensazione di sicurezza al primo sguardo.





blindati model



goccia

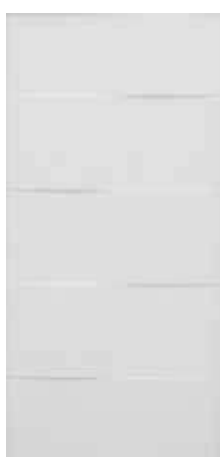

dune

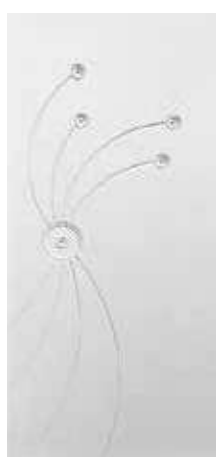

sole



linear



quadro



edge



ring



border



innovative



triangle



linear 3



bubble



fantasy



loop



p1a liscio



lady 1



p1a m



lady 2

blindati colori



noce medio



noce per esterno



tinto noce

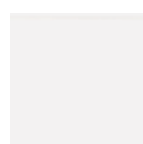

laccato bianco

Altri modelli disponibili da apposito catalogo.

blindati technic

Certificazione classe 3 antieffrazione.

Porta di sicurezza mono lamiera, in acciaio zincato, a spingere, ad un'anta con serratura silenziosa a movimento ad ingranaggi composta da un cilindro di sicurezza.

La serratura è protetta da una piastra antitrapano in acciaio sul lato esterno e lo scrocco di chiusura è agevolato da un registro antischada autoregistrante del battente posizionato sul telaio.

L'anta spessa circa 63 mm è composta da una scatola in acciaio zincato di spessore 9/10 e da tre omega di rinforzo di spessore 9/10.

La scocca è rivestita su entrambi i lati da pannello da 7 mm nelle varianti.

spioncino



cilindro europeo
e ferramenta argento
di serie

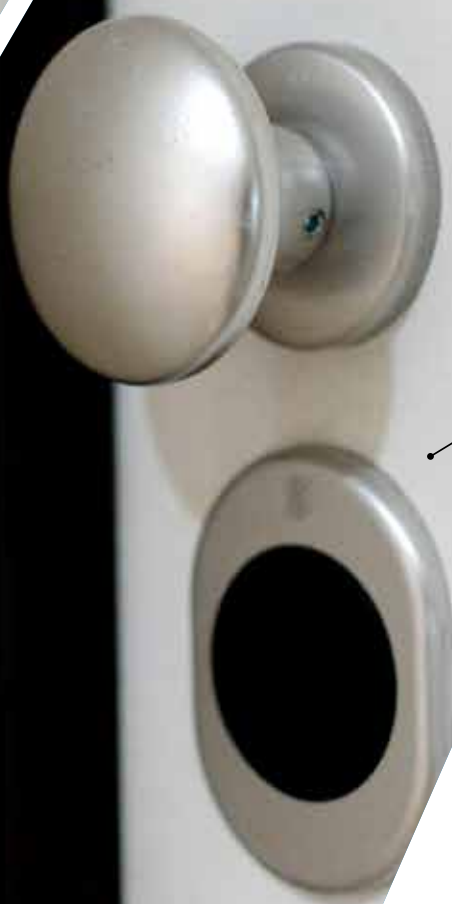

Misure disponibili

Luce netta larghezza standard	900/800
Luce netta doppia anta	800+300
Luce netta altezza standard	2100

finestre, persiane e grate





PVC

Prestazioni & design.

Ineguagliabile rapporto qualità prezzo per la linea infissi in pvc Max73 e Power9000. Isolamento termico e acustico ai massimi livelli. Valori termici da casa passiva.





pvc model



Max73



Power9000

pvc colori standard power 9000

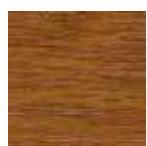

Golden-Oak 51

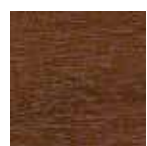

Nußbaum 21

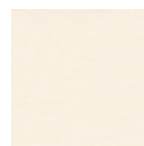

Polareiche 43
Premium

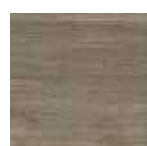

Vintage Oak 41

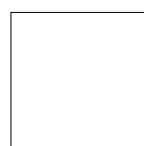

Bianco
Massa



White Ash 35

pvc colori standard max73

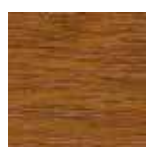

Golden-Oak 51

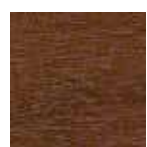

Nußbaum 21



White Ash 35



Polareiche 43
Premium



Anthrazitgrau 70



Bianco Massa



Vintage Oak 41

Altri colori disponibili da mazzetta colori.

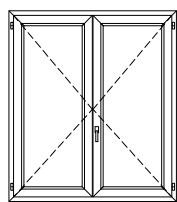

battente

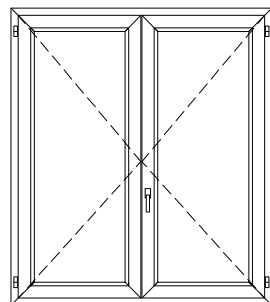

portoncino

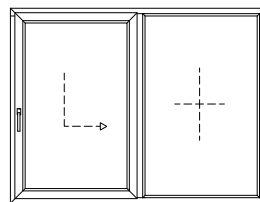

scorrevole
parallelo

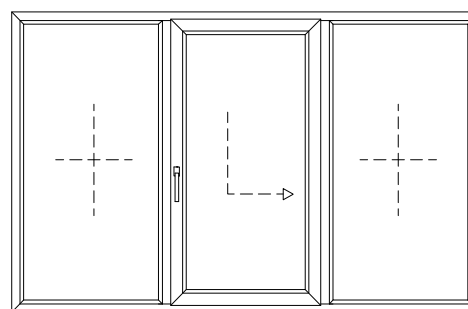

scorrevole
alzante

pvc technic

	Max73	Power9000
sezione telaio	73x68 mm	82,5x70
sezione anta	73x80 mm	82,5x90
camere	5	6
colori di serie		
	Bianco massa 01 Bianco crema 01 Nussbaum 21 Golden Oak 51 Vintage Oak 41 Anthrazitgrau 70	Bianco Massa 01 Golden Oak 51 Nußbaum 21 Polareiche 43 Vintage Oak 41
prestazioni		
trasmissione termica	Uw = 1,4 W/m²K	Uw = 1,3 W/m²K
abbattimento acustico	da 30 a 41 db	fino a 46 db
permeabilità all'aria	classe 4	classe 4
tenuta all'acqua	classe 9A	classe 9A
resistenza al vento	classe B3	classe B5
sistema di sicurezza	classe 2	classe RC2
equipaggiamenti e opzioni*		
apertura anta/ribalta di serie	si	si
telaio ristrutturazione	si	si
asta a leva su finestra 2 ante	si	si
sistemi scorrevoli paralleli	si	si
gas argon vetro camera	di serie	di serie
microventilazione	di serie	di serie
canalina warm edge	di serie	di serie
vetro Saint-gobain PLANITHERM 4S	di serie	di serie
triplo vetro camera	no	si
tipologie speciali (archi, oblò, ecc.)	si	si

ANGOLO PERFETTO NUSCO

Saldatura perfettamente liscia e compianare, che cancella le imperfezioni della saldatura, donando stile e design all'infisso

Resistenza al fuoco categoria 1

100% riciclabilità

Produzione con impiego ottimale delle risorse e scelta accurata dei materiali.

Lavorazione successiva qualitativa attraverso serramentisti qualificati.

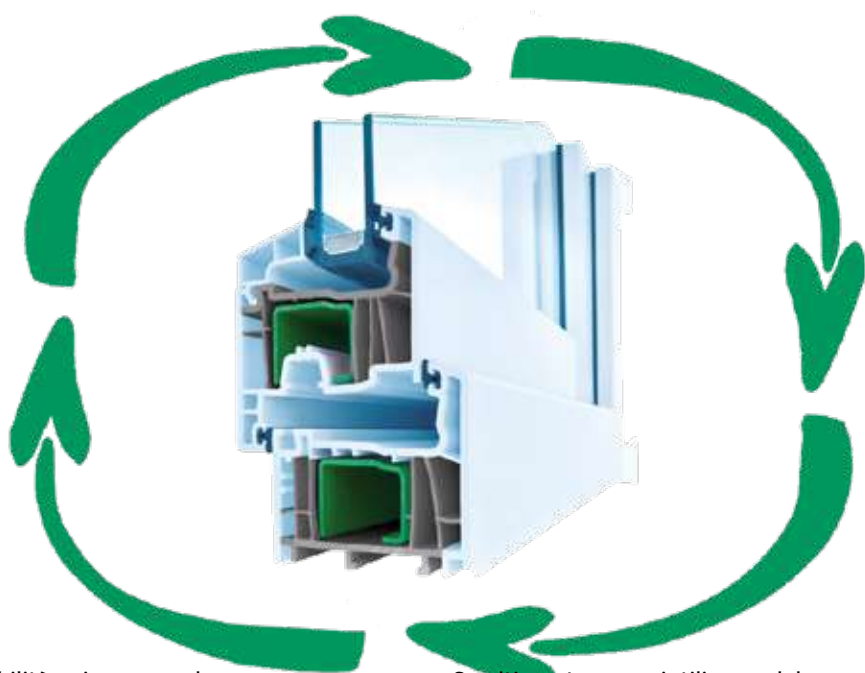

Durata, stabilità e sicurezza, elevata nonché estrema semplicità e praticità nell'uso quotidiano.

Smaltimento e riutilizzo del materiale permettono un riciclaggio completo.





LEGNO

Una scelta che premia

Serramenti tecnologicamente avanzati con un'ampia scelta di soluzioni in legno e legno alluminio.



legno model



cosmo 68 massello
listello fisso



cosmo 68 lamellare
con fermavetro



cosmo 68 flat

legno colori standard

Pino massello



noce chiaro noce medio noce scuro ciliegio

Ontano lamellare



noce chiaro noce medio noce scuro ciliegio wengè verniciato bianco

Altri colori disponibili da mazzetta colori.

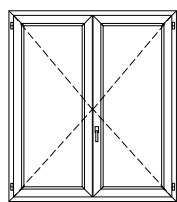

battente

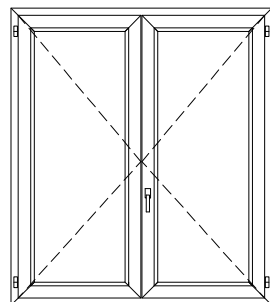

portoncino

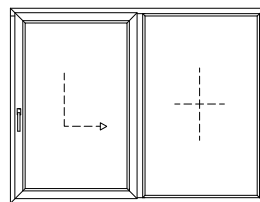

scorrevole
parallelo

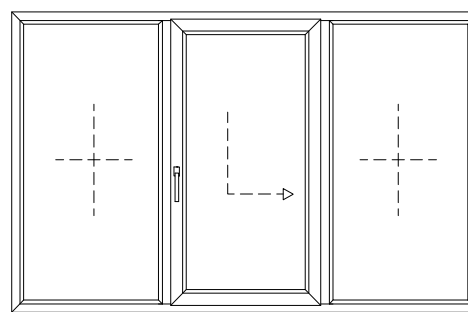

alzante
scorrevole

legno technic

Sez. anta mm. 68 x 77 con listello fermavetro oppure con listello fisso sez. mm. 68 x 80.

Finestra: vetro camera basso emissivo 33.1-12-4 As BE (con listello fisso, 33.1-16-4 As BE).

Portafinestra: vetro camera basso emissivo, parte inferiore 33.1- 10-33.1 4s BE, parte superiore 33.1-10-4 4s BE.

Nella soluzione con listello fisso, nessun traverso intermedio, tre traverse inferiori e vetro camera basso emissivo 33.1- 15 33.1 4s BE.

Di serie, cerniere tipo anuba e martellina DK Hoppe serie New York.

Ferramenta a nastro "Maico multi-matic" in acciaio finitura silver con diversi punti di chiusura.

Coprifili solo interni sez. mm. 60x10 arrotondati due lati.

Unione angoli 90°

Cerniera regolabile

Doppia guarnizione



LEGNO/ALLUMINIO

Prestazioni & design.

Serramenti tecnologicamente avanzati con un'ampia scelta di soluzioni in legno e legno alluminio.







legno/alluminio model



cosmo 68 flat

legno/alluminio colori standard

colori legno

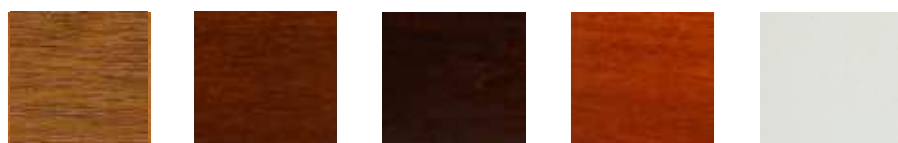

noce chiaro noce medio noce scuro ciliegio verniciato bianco

principali colori alluminio

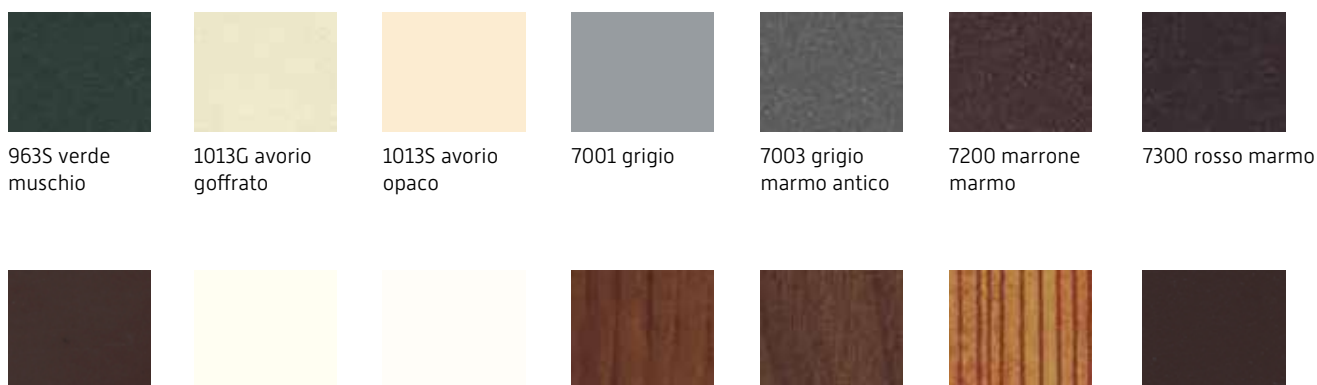

963S verde muschio 1013G avorio gofrato 1013S avorio opaco 7001 grigio 7003 grigio marmo antico 7200 marrone marmo 7300 rosso marmo
 8017K marrone 9010G bianco gofrato 9010K bianco crema castano ruvido 375 - 80 R ciliegio ruvido 317 - 70 R douglas 335 - 80 marrone ral S8017

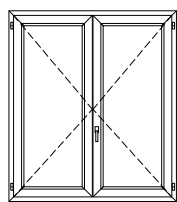

battente

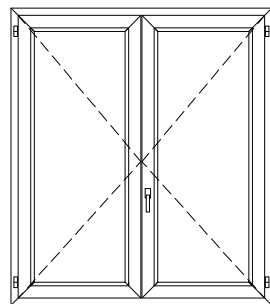

portoncino

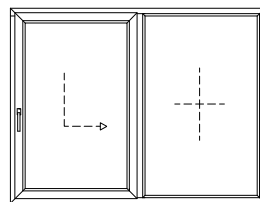

scorrevole
parallelo

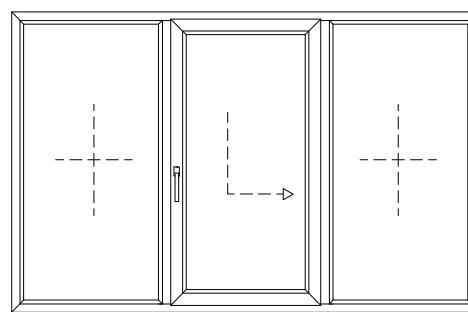

scorrevole
alzante

legno/alluminio technic

Cosmo 68 la

sez. anta mm 85x81

sez. telaio mm 83x90

finestra vetro camera 33.1 12-4 BE basso emissivo

Porta finestra vetro camera 33.1 10 33.1 4s BE

Doppia guarnizione termoacustica con ante assemblate a 90°.

Coprifili solo interni sez. mm 60x10 arrotondati su due lati.

Di serie, cerniere di tipo "anuba".

Ferramenta a nastro "Maico multimatic" in acciaio finitura silver con diversi punti di chiusura.

A disposizione una vasta gamma di colori: Ral, gotico-goffrati, effetto legno.

Doppia guarnizione



Vetrocamera Planitherm comfort 4S



sintesy model



sintesy

sintesy colori standard

L'unico infisso coordinabile alla porta!

colori legno



dress chiaro



olmo



palissandro
white



frassino bianco

principali colori alluminio



963S verde
muschio



1013G avorio
gofrato

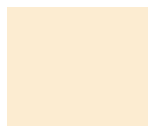

1013S avorio
opaco



7001 grigio



7003 grigio
marmo antico



7200 marrone
marmo



7300 rosso marmo

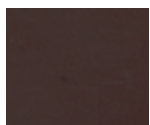

8017K marrone

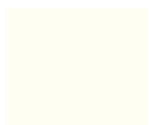

9010G bianco
gofrato

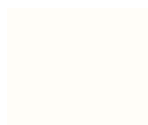

9010K bianco
crema



castano ruvido 375
- 80 R



ciliegio ruvido 317
- 70 R



douglas 335 - 80



marrone ral S8017

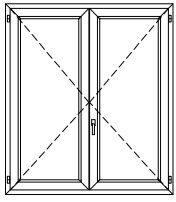

battente

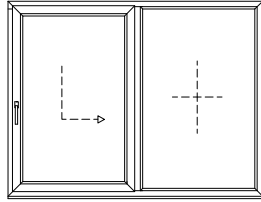

scorrevole
parallelo

sintesy technic

infissi esterni serie Sintesy W70, in LEGNO LAMELLARE FINGER JOINT, rivestito integralmente con superfici decorative sintetiche ad alta resistenza.

Anta con profilo interno squadrate, profili in alluminio complanari con giunzione ad angoli assemblati meccanicamente.

Finestre costruite con anta assemblata a 45 gradi.

Vetri con gas argon, canalina a bordo caldo di serie.

Cerniere DK con coperture finitura oro e/o argento, martellina DK in alluminio finitura oro e/o argento, ferramenta a nastro "Maico multimatic" in acciaio finitura silver a 3 punti di chiusura con nottolini a fungo già predisposti per soluzione antieffrazione completa di anta ribalta con aereazione controllata, asta a leva per infissi a doppio battente.

Profili in legno rivestiti integralmente con superfici decorative sintetiche ad alta resistenza abbinabili con numerose essenze delle porte Nusco.



L'unico infisso
coordinabile
alla porta!

prestazioni legni teneri

Trasmittanza termica $k = 1,4 \text{ W/m}\cdot\text{K}$

Abbattimento acustico 33 db

Permeabilità all'aria classe 4

Tenuta all'acqua classe 8A

Resistenza al vento classe C3

FERRO

Persiane e grate Iron

La sicurezza Nusco certificata classe 3 antieffrazione. Le persiane e grate Iron sono sinonimo di sicurezza, design e qualità. La ricercatezza estetica e la capacità di adattamento a tutti i contesti urbani rendono le persiane e le grate Nusco ideali per soddisfare ogni tipo di esigenza, in primis per la loro solidità e capacità di resistenza, ma anche per le più semplici funzioni di oscuramento e difesa dalle intemperie esterne.





grate model



luce 2 small



luce 1 evol



luce 3 large



iron
lamelle fisse



iron orienta

Numerose colorazioni disponibili da catalogo specifico.

grate model

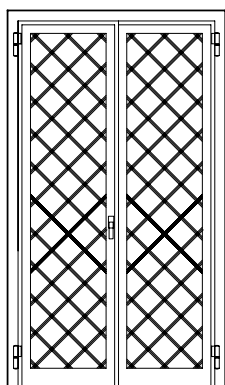

PEGASO

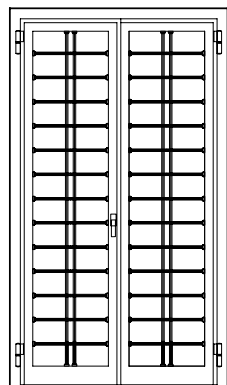

GEMINI

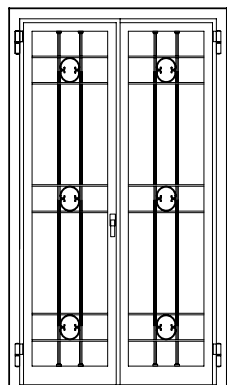

ANDROMEDA

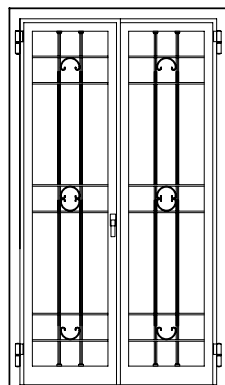

DRAGO

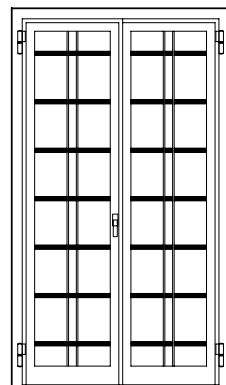

SAGITTO

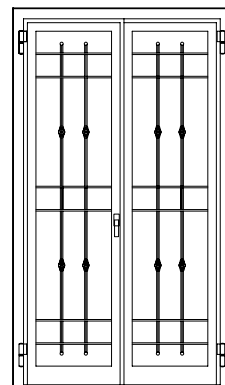

VIRGO

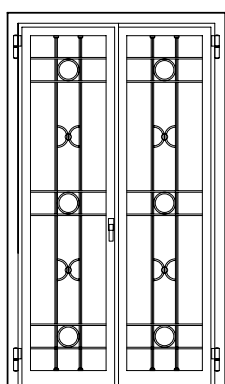

SCORPIO

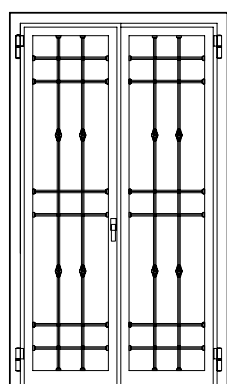

SIRIO

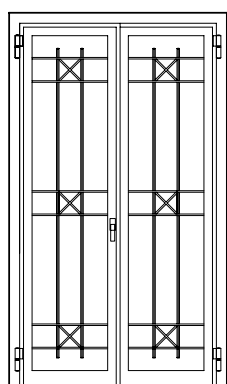

CRISTAL

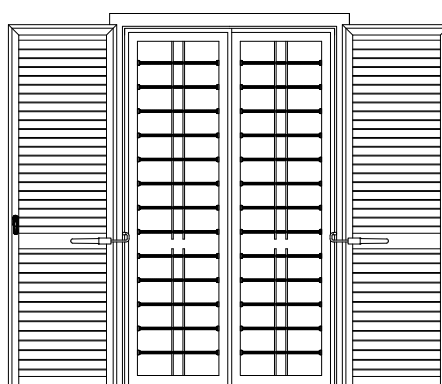

COMBINATA

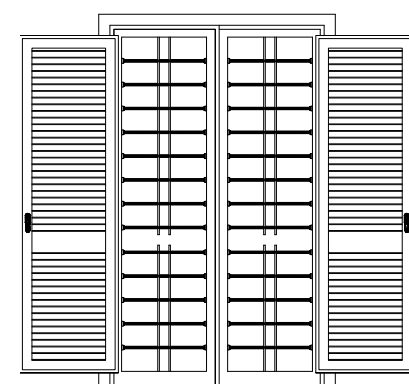

DUETTO

grate technic

Persiane

Battente con lamelle fisse inclinazione a 30° Acciaio zincato a freddo.

Ante realizzate con sezione 40×60 mm spessore 15/10.

Profilo lamella fissa 50×10 sp.12/10 bloccate con sistema antisfilamento a tondino passante 6 mm.

Zoccolo di base di altezza da 105 a 135 in lamiera zincata 15/10.

Telaio fisso a zeta disponibile in due tipologie: LINEAR e BOMBATO.

Cerniere a tappo di diametro 22 mm, altezza 140 mm fornite con pernodisponibile anche nella versione con lamelle orientabili

Grate

Sfilabili e cuscinetto (n°2 per anta sia su finestra che su portafinestra).

N°2 rostri antistrappo per finestra e n°3 per portafinestra, chiusura con serratura a triplice chiusura a bascula, mezzo cilindro europeo con chiave piatta, paletti di chiusura a leva in acciaio zincato.

Maniglie e copricilindro di colore nero di serie Fermapersiana top grillo in nylon.

Lamelle orientabili

classe 3
antiefrazione

Dimensione luce variabile

ALLUMINIO

design e performance

Linee essenziali ma dal design ricercato per la nostra linea di oscuranti in alluminio.

Resistenza, affidabilità e sicurezza, versatilità nelle forme e nello stile, rendono le persiane in alluminio Nusco adattabili ad ogni contesto abitativo.







alluminio model



CX 700



CX 700 AST



CX 700 ASW



CX 850



RX 450



SX 110



HX 160

alluminio colori standard

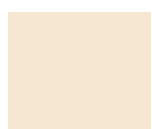

RAL 1013



RAL 9010



RAL 6005



RAL 8017

Disponibili ulteriori colori standard glitter, ossidati, polvere su polvere, natural e sublimati.
Visionare specifica mazzetta colori.

alluminio technic

	 Permeabilità all'aria UNI EN 12207	 Permeabilità all'acqua UNI EN 12208	 Permeabilità al vento UNI EN 12210	 Finestra a 1 anta* Isolamento termico UNI EN ISO 10077-2	 Finestra a 2 ante(1230x1480) Isolamento termico UNI EN ISO 10077-2	 Abbattimento acustico UNI EN ISO 140-3
CX 700	classe 4	classe E 1200	classe C5	1.51/1.15 W/m ² K		fino a 45 dB
CX 700 AST	classe 4	classe E 1500	classe C4	1.22/0.80 W/m ² K		fino a 44 dB
CX 700 ASW	classe 4	classe E 1500	classe C4	1.25/0.84 W/m ² K		fino a 44 dB
CX 850	classe 4	classe E 1200	classe C5		1.08 W/m ² K	fino a 45 dB
RX 450	classe 3	classe 5A	classe C3			
SX 110	classe 4	classe E 900	classe C3		2.0 W/m ² K	fino a 41 dB
HX 160	classe 4	classe 9A	classe C3			



Valori energetici da casa passiva

Uw fino a 0,80 W/m²K

- Ampia disponibilità di colori e tipologie
- Massima adattabilità ad ogni contesto urbano



alluminio persiane model



Oscuria

alluminio persiane colori standard

principali colori alluminio



963S verde muschio



1013G avorio gofrato

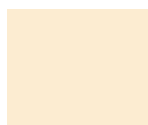

1013S avorio opaco



7001 grigio



7003 grigio marmo antico



7200 marrone marmo



7300 rosso marmo

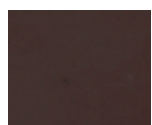

8017K marrone

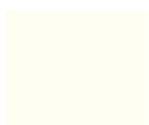

9010G bianco gofrato

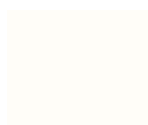

9010K bianco crema



castano ruvido 375 - 80 R



ciliegio ruvido 317 - 70 R



douglas 335 - 80



marrone ral S8017

PERSIANA OSCURIA
SCORNICIATA (BASE)

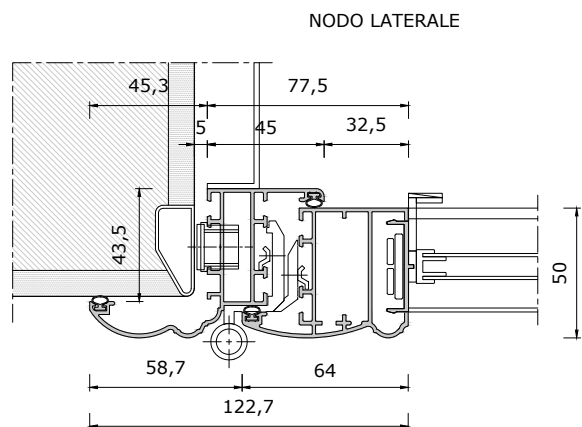

PERSIANA OSCURIA
MODELLO PIATTO

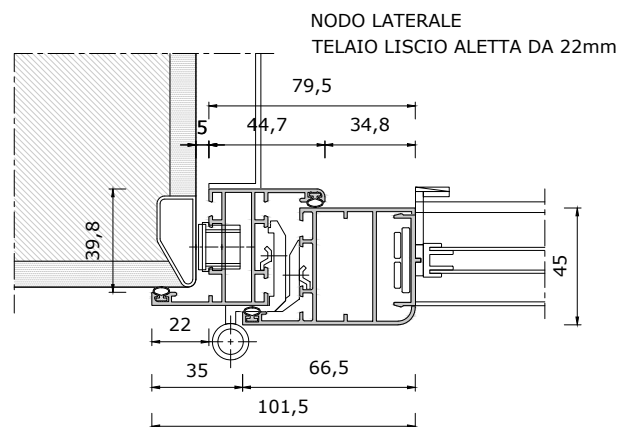

PERSIANA OSCURIA
SCORNICIATA (BASE)

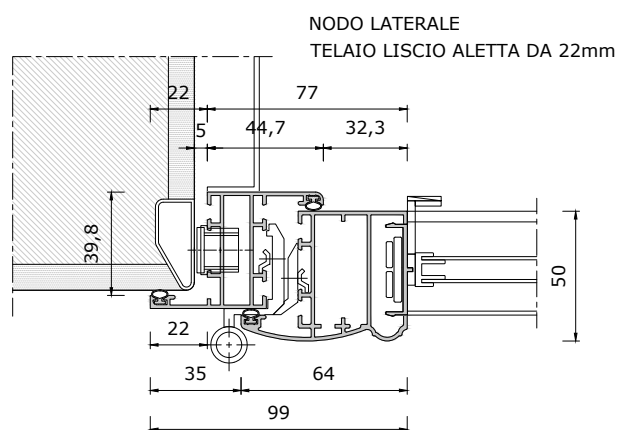

PERSIANA OSCURIA
STORICA

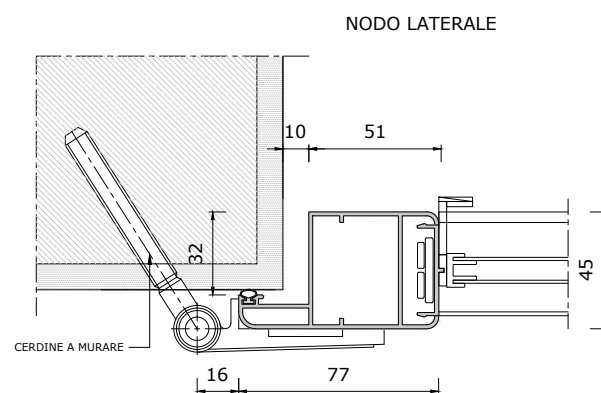

oscuria technic

Oscuria

Persiana battente con lamelle fisse con inclinazione a 30° o orientabili mediante maniglie a leva.

Profilati in lega d'alluminio 6060 secondo le normative vigenti.

T5 secondo la norma UNI EN 515 (equivalente TA 16).

Telaio fisso per fissaggio interno 45mm, 80mm con aletta di battuta sagomata.

Anta sezione 50x64 mm (profilo bombato).

Cava per alloggiamento meccanismo 36mm.

Scuretto tra i profilati 5mm.

Cerniere 2 ali, chiusura con cremonese.

A disposizione una vasta gamma di colori: Ral, gotico-goffrati, effetto legno.



NUSCO
ispirati dalla tradizione, progettati al futuro

NUSCO

ispirati dalla tradizione, progettati al futuro

Sede principale, produzione e store

Nola [NA] - S.S. 7/bis Km. 50.500

Store e franchising

Aversa [CE] - viale della libertà, 28
Battipaglia [SA] - Via Belvedere 142/144
Benevento - contrada San Vito 139 [rotonda c.c. Buonvento]
Boscotrecase [NA] - Via Sepolcri, 12
Brindisi - Via Osanna, 6
Caivano [NA] - Via S.S. Sannitica, 87 - Km 14.300
Castellammare di Stabia [NA] - via Cavour, 19
Casagiove [CE] - via Appia, 219
Casoria [NA] - s.s. Sannitica km 7.540
Castel San Giorgio - Via Palmiro Togliatti, 6
Cinisello Balsamo [MI] - via Edmondo De Amicis, 39
Ercolano [NA] - Via S.B. Cozzolino, 110 C
Fondi [LT] - Corso Appio Claudio, 71
Giugliano [NA] - Via Colonne, 80
Cinisello Balsamo [MI] - via Edmondo De Amicis, 39
Mirabella Eclano [AV] - via Nazionale, 51
Mugnano [NA] - Corso Italia, 128
Napoli - via Cilea, 223
Napoli - Fuorigrotta - via Giulio Cesare, 13
Napoli - via Marina 20/24, angolo via Duomo
Napoli - via Salvator Rosa, 249/b
Nocera Superiore [SA] - via Nazionale, 923
Pianura [NA] - Via Montagna Spaccata, 327
Pompei [NA] - Via Lepanto, 188
Pomigliano d'Arco [NA] - via Nazionale delle Puglie 209/211
Portici [NA] - corso Garibaldi 43/45
Potenza - c/da Varco D'Izzo
Riardo/Pietramelara [CE] - via Croce di Riardo (a 300 mt. Fiera del Mobile)
Rimini - Via Marecchiese, 19
Roma - Via Gregorio VII, 298
Roma - Via Somalia, 175
Roma - Via di Santa Costanza, 15
Roma - Via Antonio Pacinotti, 37/39
Roma - Via dei Prati Fiscali, 150
Salerno - via Richard Wagner, 42
San Giorgio a Cremano [NA] - via delle Repubbliche Marinare, 420/422
Sant'Arpino [CE] - s.p. per Frattamaggiore, 19
Sciacca [AG] - via Carlo Marx, 1
Sorrento [NA] - viale degli Aranci, 31/G
Teramo [TE] - viale Galileo Galilei
Torre del Greco [NA] - Corso Avezzano, 47
Torrette di Mercogliano [AV] - via Nazionale, 102
Tufara Valle [AV] - via Appia ss7, 78D
Verona - Via Copernico 29, angolo via dell'Esperanto
Villaricca [NA] - via Napoli 126

nuscospa.com

info@nuscoporte.com

